



LM1012

TABLE-TOP LABEL APPLICATOR SYSTEM OPERATIONS MANUAL



Manufactured in USA by:

LabelMill, Inc.

2416 Jackson St.

Savanna, IL 61074

(800) 273-4707

info@labelmill.com

www.labelmill.com

TABLE OF CONTENTS

SECTION	PAGE
1. SYSTEM OVERVIEW	
Introduction	4
General System Specifications	5
Inventory List	6
User Responsibility & Safety	7
2. SETUP AND OPERATION	
LM1012TTS Component Description	9
Web Routing	10
Label Sensor Adjustment	11
Label Sensor Calibration	12
Mechanical Clear Label Detector	13
Electronic Clear Label Detector	14
Drive Motor Pack	15
3. PROGRAMMING & CONTROL OPERATION	
System Controls / Operator Interface	17
Control Accessory Connections	18
Programming	19
Quick Programming Flow Chart	22
Key Definitions	32
Set Up of Key Features	33
Input & Output Description	35
4. OPTIONAL APPLICATION MODULES	
Tamp Applicator Module Installation	39
Flag Applicator Module Installation	41
Round Product Applicator Module Installation	43
Auto Round System Module Installation	45
Remote Start Module	46
Valve Pack	47
Module Air Connections	48
Peeler Plate Adjustment	49
External Printer Interface Connection	50
5. TROUBLESHOOTING & MAINTENANCE	
Troubleshooting	52
Fault Codes	53
Storage Spool Brake Adjustment	54
Replacing the Main Power Fuse	55

SECTION 1

SYSTEM OVERVIEW

Introduction	4
General System Specifications	5
Inventory List	6
User Responsibility & Safety	7

INTRODUCTION

The **LabelMill LM1012TTS** is a microprocessor controlled, variable speed, heavy-duty industrial table-top label application system. Label dispensing speeds up to 1400 linear inches of label web per minute is combined with exceptional label position repeatability. Automatic feed on label removal. Outboard-supported drive roller to minimize vibration induced label misplacement. Heavy-duty hybrid-servo motor drive. Hardened steel peeler plate for reduced wear. Adjustable label sensor for expediting changeover without sacrificing accuracy. The **LM1012TTS** will accept a wide variety of label sizes without the need for part changes. This system can be quickly and easily configured to meet your labeling needs. There is no need for multiple machines with this design. The unique rail mounted application modules makes changeover from one module to another in 5 minutes or less.

STANDARD FEATURES

- Modular Design
- Easy Set-Up
- Electronic Label Sensor

OPTIONAL APPLICATOR MODULES

- Tamp Applicator
- Flag Applicator
- Round Product Applicator
- Auto-Round Module

LM1012TTS SPECIFICATIONS

LABEL SPEED	0 - 1400 linear inches of web per minute standard
LABEL ROLL CAPACITY	12" Max. outside diameter wound on a 3" diameter core. Die cut waste removed with a minimum of 1/8" separation between labels in running direction.
LABEL SIZE	Minimum: 1/2" wide x 1/2" long - Maximum: 4.5" wide x 10" long
LABEL PLACEMENT ACCURACY	Up to 1/32" (1mm) when labels are produced to specifications and product handling is controlled.
INTERFACE SENSORS	Product Sensor-Photo Eye-Limit Switch, Label Sensor Switch, Head Up Limit Switch, and Round Product Tamp Switch.
ELECTRICAL	115 V AC/60 Hz - 2A
AIR REQUIREMENT	80p.s.i. / 3 cfm
SIZE	26"H x 20"W x 24"D
WEIGHT	40 lb.
ENVIRONMENT	Operating Temp. 50-95 F. (10-15 C.) - 15-85% RH. non-condensing

*Options Available

INVENTORY LIST

Standard Equipment - LM1012

QTY. Description

- 1 Dispenser Assembly
- 1 12" Diameter Blue Plastic Spools w/ Quick Release Collar
- 1 12' Power Cord
- 1 Adjustable Electronic Label Sensor
- 1 Take-Up Spool Clip
- 2 Module Mounting Knobs
- 1 Model LM1012 Operators Manual

Optional Tamp Module - LM1012TM

QTY. Description

- 1 Tamp Module Assembly

Optional Flag Module - LM1012FM

QTY. Description

- 1 Flag Module Assembly

Optional Round Product Module - LM1012RM

QTY. Description

- 1 Round Product Module Assembly

Optional Auto Round System Module - LM1012ARS

QTY. Description

- 1 Auto-Round Product Module Assembly

USER RESPONSIBILITY

This equipment will perform in conformity with the description thereof contained in this manual and accompanying labels and/or inserts when installed, operated, maintained, and repaired in accordance with the instructions provided. This equipment must be checked periodically. Defective equipment should not be used. Parts that are broken, missing, plainly worn, distorted, or contaminated should be replaced immediately. Should such repair or replacement become necessary, we recommend that a request for service advice be made.

This equipment or any of its parts should not be altered without the prior written approval of LABELMILL. The user of this equipment shall have the sole responsibility for any malfunctions which results from improper use, faulty maintenance, damage, improper repair or alteration by anyone other than LABELMILL or a service facility designated by LABELMILL.

SAFETY

Only qualified personnel should use this equipment.

Before installing, inspecting or servicing equipment, turn OFF all power and air controls at the source and lock out in accordance with OSHA Standards.

Be sure all external electrically conductive parts are connected to a good electrical ground.

Never handle live electrical equipment with bare hands while standing in water, or while hands and feet are wet.

Dangerous electrical shock can result.

Whenever the equipment is unattended, turn off all control and power supply switches.

Keep equipment clean and in good operating condition. Promptly repair or replace all worn or damaged hoses, cables or parts.

Do not make any repairs to equipment unless you are fully qualified.

This equipment contains fast moving parts that may move without warning. Keep hands, loose hair and clothes clear of machines at all times.

Never place hands or any other body parts under the label platen at any time.

This equipment uses compressed air. Proper care and maintenance must be taken when handling compressed air and its components.

These precautions are further detailed and explained where specifically required in this manual.



WARNING

READ AND UNDERSTAND THESE INSTRUCTIONS

Protect yourself and others. Be sure this information is read and understood by all operators.

ELECTRICAL SHOCK CAN KILL!

Do not touch live electrical parts with bare skin or work with gloves or wet clothing.

NOISE CAN DAMAGE HEARING!

Wear proper ear protection.

SECTION 2

SETUP & OPERATION

LM1012TTS Component Description	9
Web Routing	10
Label Sensor Adjustment	11
Label Sensor Calibration	12
Mechanical Label Detector Setup	13
Electronic Clear Label Detector Setup	14
Drive Motor Pack	15

COMPONENT DESCRIPTION

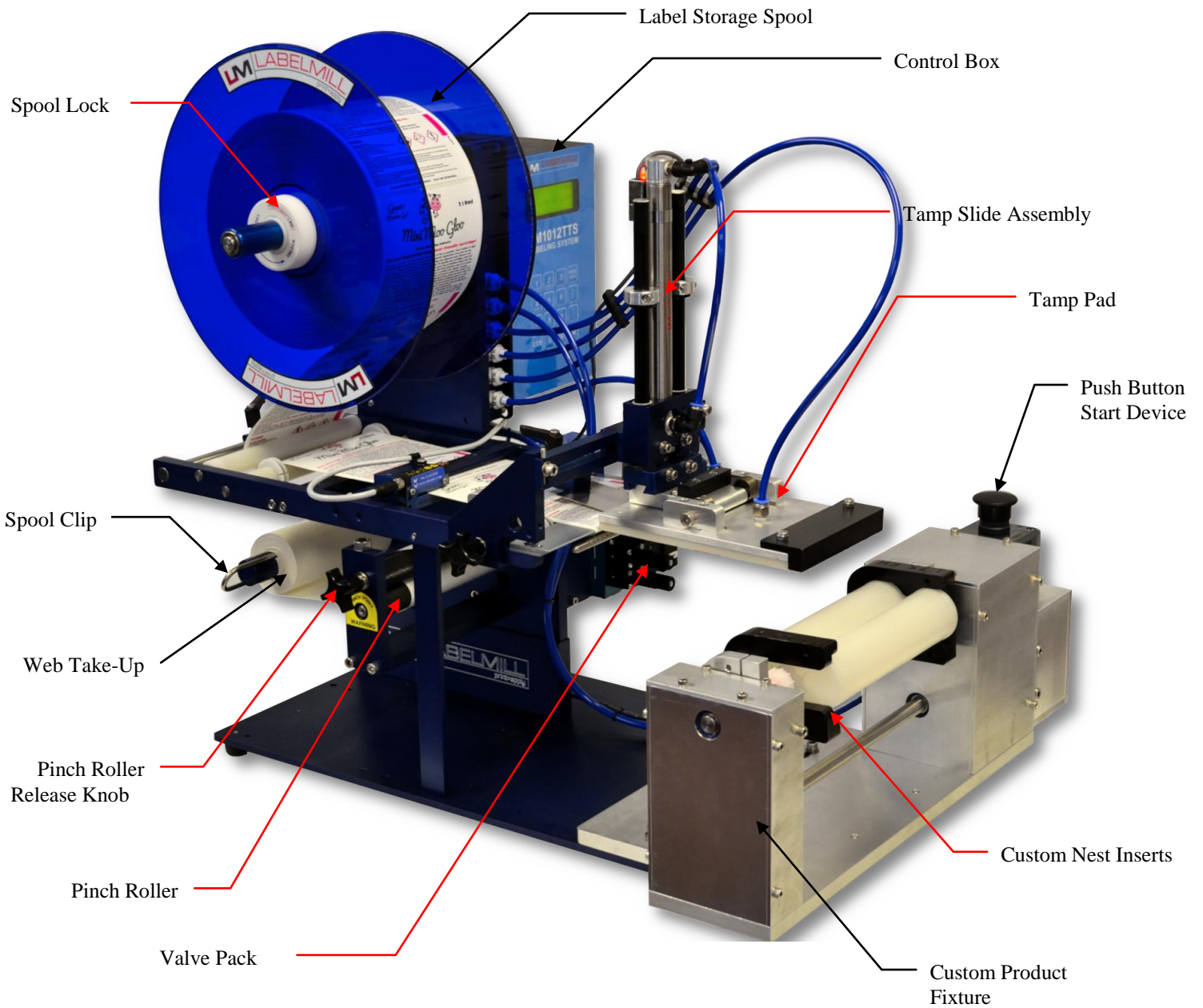

WEB ROUTING

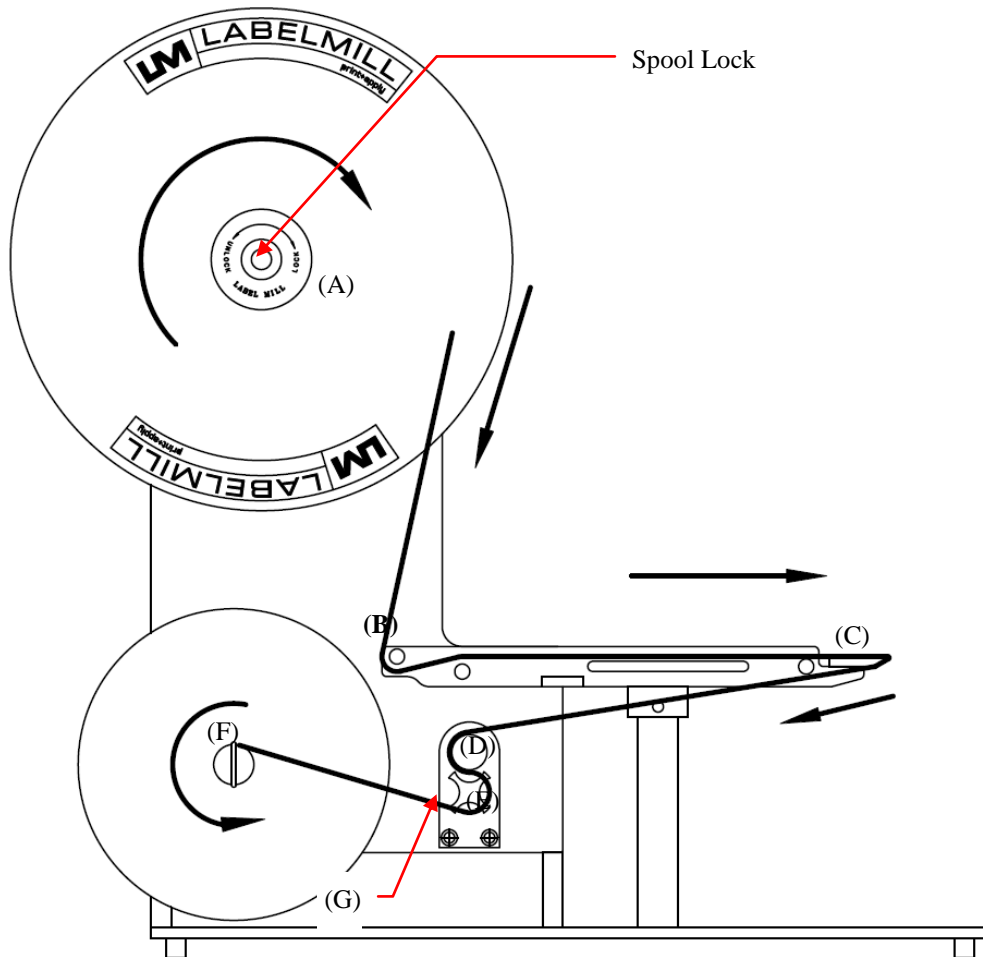

Step	Operation
1	Load web onto label storage spool (A) so it unloads in a clockwise direction.
2	Insert the web under the first guide roller and over the second guide roller (B).
3	Wrap the web around the peeler plate (C), continuing on to the drive roller (D).
4	Turn the Pinch Roller Knob (G) 180deg. to open the pinch roller from the drive roller.
5	Feed the web over the top drive roller (D). Next, slip the web between the drive roller and the pinch roller (E). Continue on by wrapping the web under the drive roller.
6	Finish the process by loading the waste backing paper onto the web take-up spool (F). The take-up spool rotates in a counter-clockwise direction.
7	Turn the Pinch Roller Knob (G) 180deg. so that the pinch roller and drive roller contact each other. When the roller is closed, roll the knob back and forth between your fingers so that you can feel a "flat" on the shaft. NOTE: This must be done to ensure proper label feeding.
8	Adjust the plastic web guide clips so the web is guided straight and even. Make sure the clips do not bind the web.
9	Lock the wiper assemblies near roller (B) and at the peeler plate (C) with light pressure to keep proper tension the system and to assist in peeling the label from the liner.

** To remove the label storage spool (A), turn the spool lock counter-clockwise (approx. 15 deg.) until you reach a stop. The spool will now slide off. To secure the spool, simply turn the spool lock clockwise until snug. DO NOT over tighten the spool lock!

Z-Z-ELS-100 LABEL SENSOR ADJUSTMENT

***Note that the control must be programmed for the label sensor to work properly. The Z-Z-ELS100 label sensor must be set to the "Clear" setting in the Label Sensor menu.**

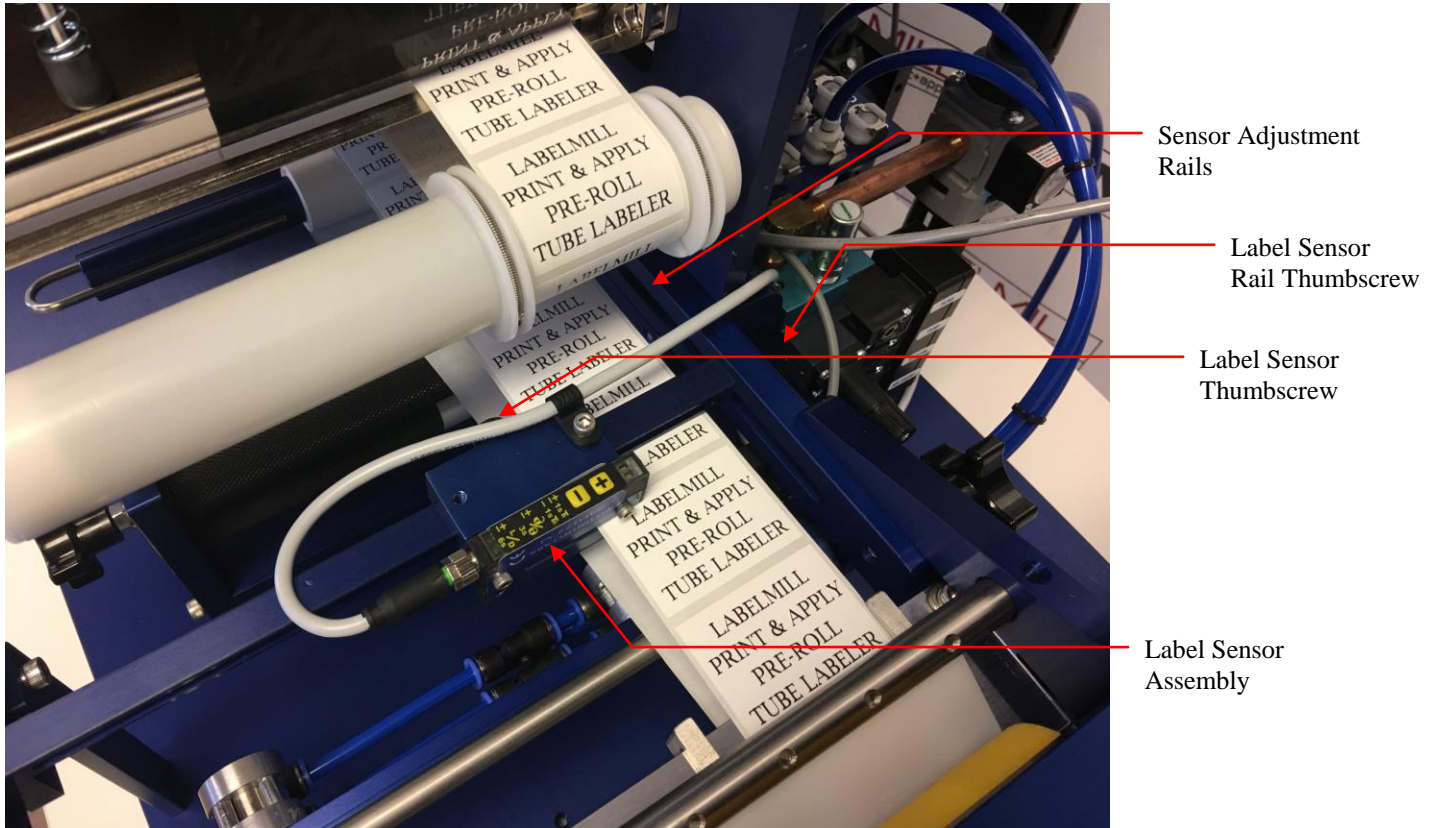

LABEL PLACEMENT IN RELATION TO THE PEELER PLATE

Loosen the lock screw on the photo eye rail assembly and slide it forward or backward on the rails to achieve placement of the label with the peeler plate nose (+/- 1/32). After adjustment, cycle the labeler to verify new label placement.

Z-Z-ELS100 LABEL SENSOR SETUP INSTRUCTIONS

Teach Mode Setup Procedure:

1. Place the web liner in the sensor (remove a label or use the label gap). Press the [+] and [-] buttons at the same time for less than one second. The red LED will begin to flash.
2. Place the web liner, **with a label**, in the sensor. Press the [-] button for less than one second. The red LED will stop flashing.
3. The automatic setup is complete. (Steps 1 and 2 can be reversed)



Manual Sensitivity Adjustments:

The "Teach Mode Setup" should always be successful. However, the sensitivity can be adjusted manually by pressing the [+] or [-] buttons. The red LED will flash with each button press.

Locking/Unlocking the Setup:

Press and hold the [+] and [-] buttons for three seconds (but less than six seconds). The red LED will change state. When the buttons are released, the red LED will then indicate locked (red LED on) or unlocked (red LED off).

Light/Dark Switching:

Press and hold the [+] and [-] buttons for six seconds. When the mode is changed, the red LED will begin to flash slowly until the buttons are released.

OPTIONAL MECHANICAL CLEAR LABEL DETECTOR

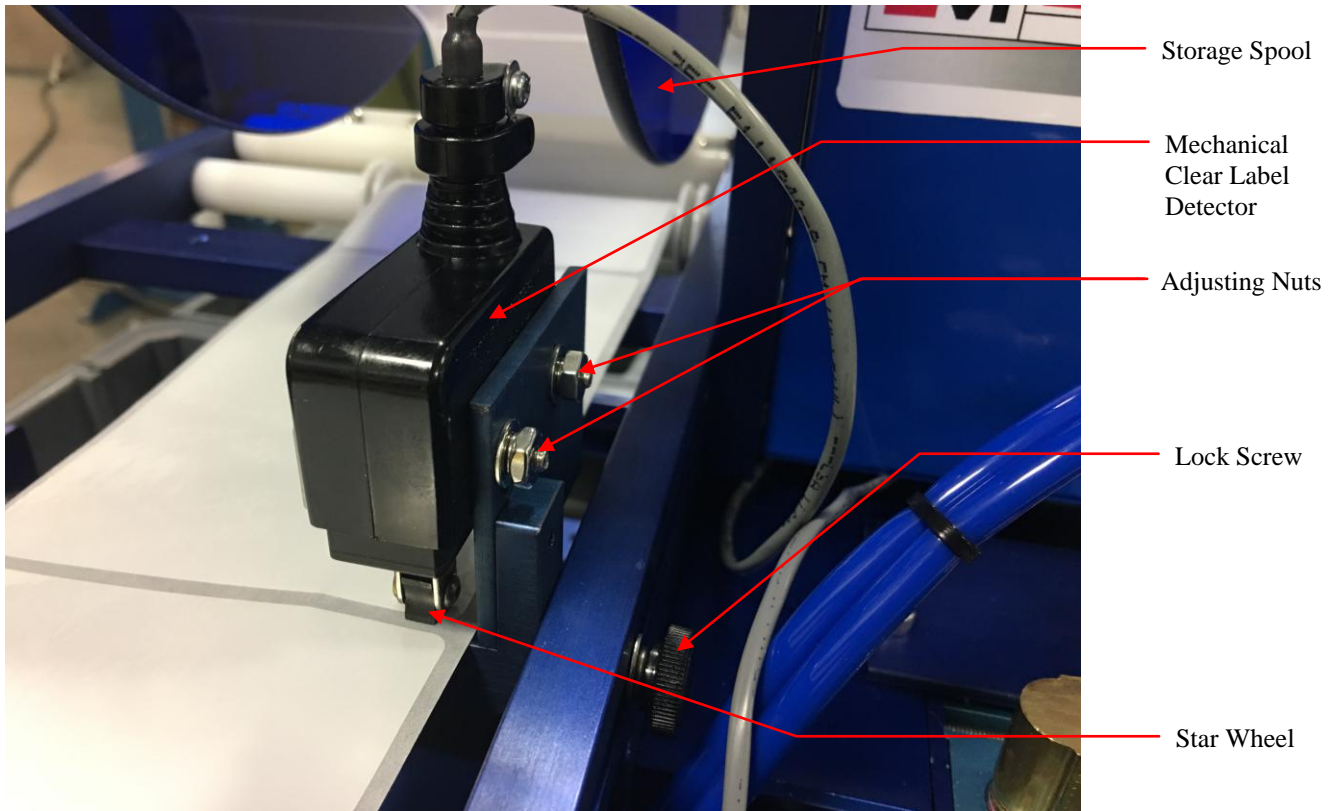

The Mechanical Clear Label Detector comes preset from the factory and should require no adjustment. If there is a need to readjust the sensor, the following is a guide: Move the label stock until the gap between the labels is centered under the Star Wheel and the star wheel is laying flat on the label stock as shown above. This can be accomplished by unwinding the label storage spool enough to make the web "loose". To test adjustment, move the label stock gap back and forth under the photo eye slowly. The STAR WHEEL catches the edge of the label stock and flips from one flat to the next. The STAR WHEEL detects the gap between the labels by catching the edge of the label as it is fed. When the star wheel catches the edge of the label, the wheel will quit sliding and rotate. The diameter across the flats of the star wheel is smaller than the diameter across the points. When the star wheel rotates, the micro switch is activated indicating the gap in the label stock.

If double or multiple label feeding occurs, and the micro switch is always activated, loosen the adjustment nuts and slide the micro switch up away from the label.

If double or multiple label feeding occurs and the micro switch never activates, loosen the adjustment nuts and slide the micro switch down towards the label.

LABEL PLACEMENT IN RELATION TO THE PEELER PLATE:

- Loosen the lock screw on the **Mechanical Label Sensor Assembly** and slide it forward or backward on the adjustment rails to achieve placement of the label with the peeler plate nose (+/- 1/32). After adjustment, cycle the labeler to verify new label placement.

OPTIONAL ELECTRONIC CLEAR LABEL DETECTOR (ECLD)

Description

The Z-Z-ELC300 Label Sensor uses capacitive technology to sense label edges for registration, counting, splice detection or other applications. Capacitive technology provides the fastest and most accurate edge detection method available. The Z-Z-ELC300 has an integral cable, and uses an M12 connector.

Setup

1. Web must remain in contact with the base/mounting plate during operation.
2. Label must pass under the [-SENSOR-] indicator.
3. Small labels should be centered under the [-SENSOR-] indicator.
4. When properly setup, the lights in the gray LABEL area will be on when a label is present, and lights in the gray GAP area will be on when a gap is present.
5. All lights flashing rapidly indicates over-current condition, likely caused by wiring error.

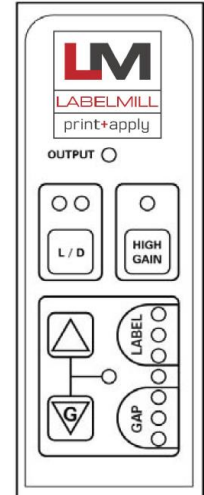

AutoGap Setup

1. Start with High Gain off.
2. Remove a label from the web.
3. Place the area of the missing label in the sensor (liner only).
4. Press **G** for at least 1 second (lights begin to move back and forth).
5. Release the button.
6. Setup complete.
7. Verify the light bar goes into the gray GAP area during gaps between labels and into the gray LABEL area during labels. If necessary, use arrow keys to adjust manually. If the light bar is not moving at least three or four lights, turn on High Gain.

Manual Adjustment

When running, the light bar should extend from the gray LABEL area to the gray GAP area. The up and down arrows can be used to fine tune the adjustment if necessary. If the adjustments reach the end of their range, the last light in the GAP or LABEL area will flash three times when the button is pressed. The light bar may move toward LABEL while the Up arrow is pressed. This is because the sensor body is deflecting and making the slot smaller. It will return when the button is released and will not affect setup.

Sensor Configuration

Light/Dark Switching In "Light" switching mode, the sensor outputs are active/on during the gap. In switching mode, the sensor outputs are active/on during the label. Switch modes by pressing the **L/D** button. Do not change while running.

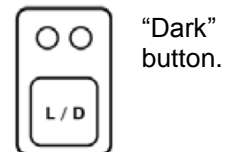

High Gain Mode

Only use High Gain mode when necessary. Very small or very thin labels may not consistently move bar between the LABEL and GAP areas. In this case, use the High Gain mode by pressing the **HIGH GAIN** button. Do not change while running. AutoGap must be performed after activating High Gain.

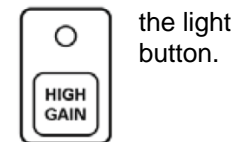

Metal/Foil Label Setup

AutoGap Setup on a missing label area may not work reliably for rectangular metallic labels (foil or metalized Mylar). In this case, place an actual gap in the sensor (use alignment groove on the sensor). Then hold the Gap button down for AutoGap as above. Move labels slowly through the sensor. Use manual adjustments if necessary to ensure the light bar is in the LABEL area during labels and GAP area during gaps.

DRIVE MOTOR PACK

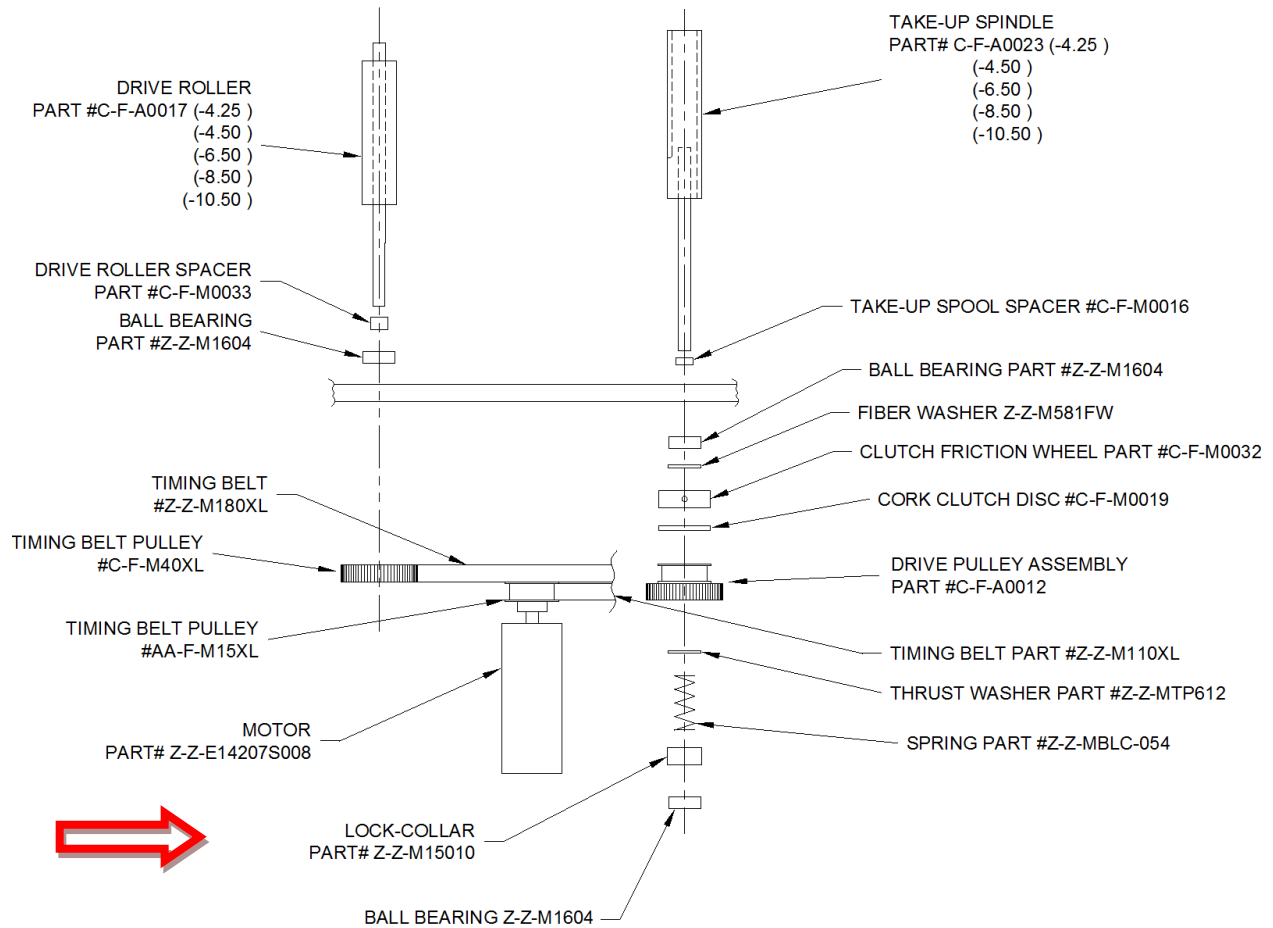

To reduce waste web tension, move the lock collar 1/32" away from the take-up spool. To increase web tension, move the lock collar 1/32" toward the take-up spool.

CAUTION! Too much web tension may cause web breakage, label drifting, or premature failure of the take-up spool assembly.

SECTION 3

PROGRAMMING AND CONTROL OPERATION

System Controls / Operator Interface	17
Control Accessory Connections	18
System Programming	19
Programming Flow Charts	22
Key Definitions	32
Set Up of Key Features	33
Input & Output Description	35

SYSTEM CONTROLS / OPERATOR INTERFACE

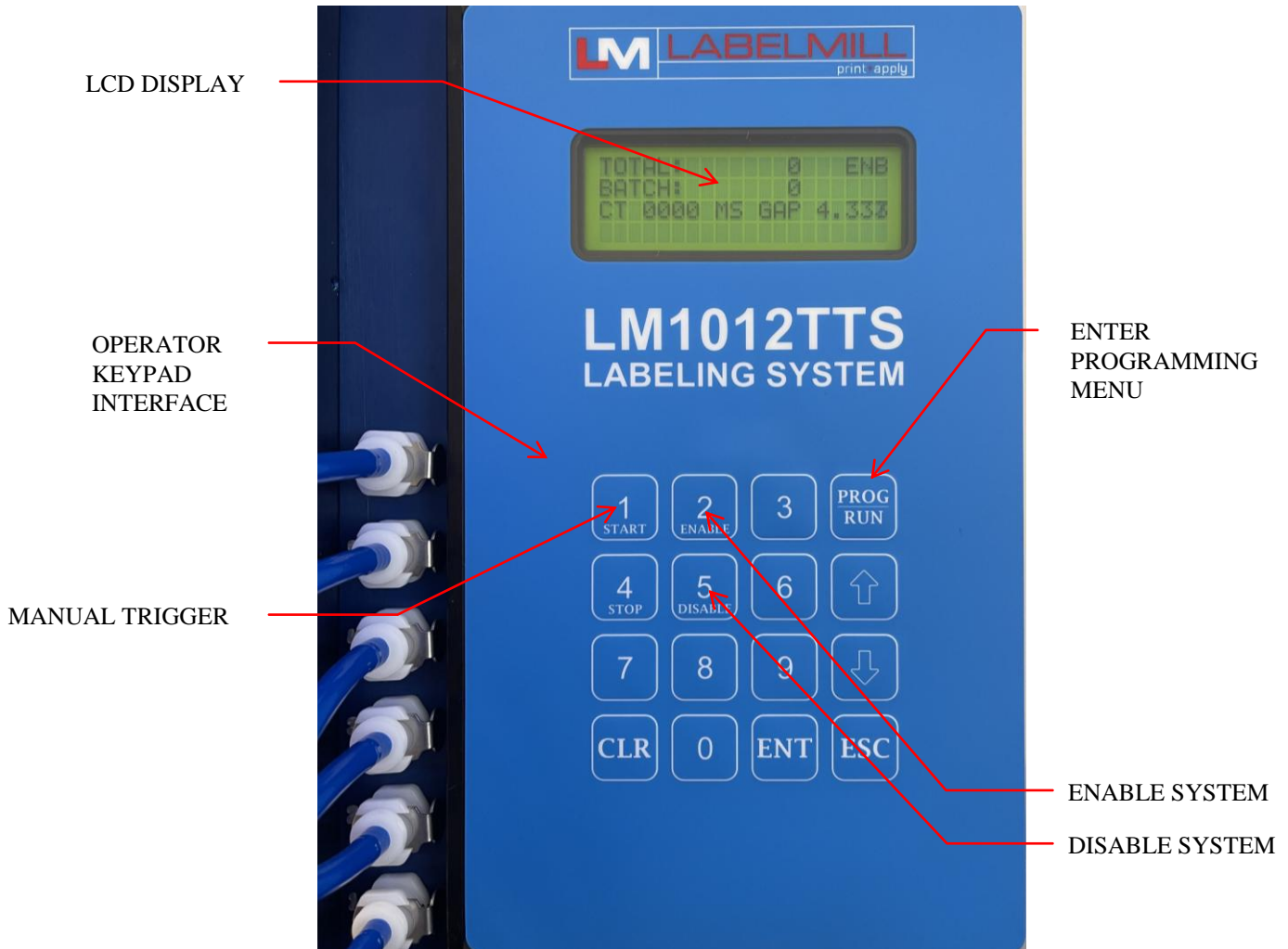

ACCESSORY CONNECTIONS

LOCATED ON BACK OF CONTROL BOX

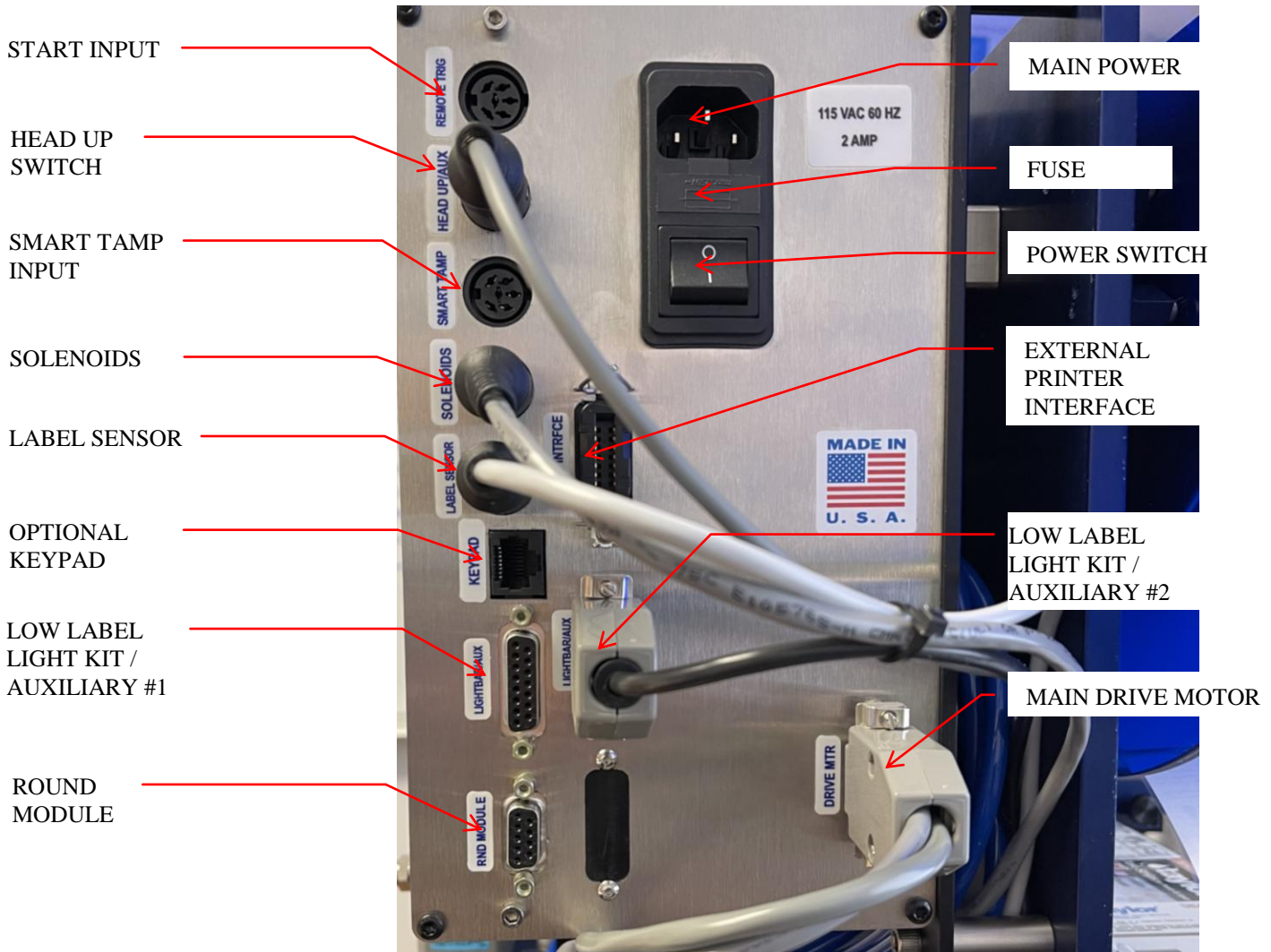

SYSTEM SETUP

PROGRAMMING

All programming is performed via the keypad located on the front of the control box. All programmed settings are backed in nonvolatile memory and are not lost when the unit is powered off.

Upon power up of the control, the screen will display *MODEL NUMBER & REVISION* of the control box and then the *MODEL NUMBER & REVISION* of the labeler system. After this, the screen will now display the main screen and counters.

• KEY FUNCTIONS:

“PROG” PROGRAM KEY IS USED TO:

1. **Enter and exit** the program menu.

“ENTER” KEY IS USED TO:

1. Access or “Enter” the selected “PROGRAM BLOCK”. (example TAMP SETUP)
2. Access or “Enter” the **data selection/options** line of the “PROGRAM BLOCK” **Sub Menus**.
3. Store the selected data.

UP / DOWN ARROW KEYS ARE USED TO:

1. Scroll up & down through the primary menu “PROGRAM BLOCKS” . (Header name)
2. Scroll **sub menus** inside of “PROGRAM BLOCKS”.

START KEY:

1. Start key will initialize the application cycle.

STOP KEY:

1. Stop key will abort the application cycle.

ENABLE KEY:

1. Enable key will “Enable” the drive after it has been disabled.

DISABLE KEY:

2. Disable key will “Disable” the drive if it is currently enabled.

CLEAR KEY:

1. Clear key will delete stored values while in the edit mode.

ESC (escape) KEY:

1. Will back out of the sub programming menu without saving changes.

• **PASSWORD**

The PASSWORD is used to lock the menus of the control. This option is used to prevent unauthorized access to variable data. When shipped from the factory, the password is to 7074 and NO MENUS are locked. The factory password cannot be changed. An alternate user password can be set to lock specific menus in the control.

• **I/O STATUS**

Displays the status of the inputs and outputs.

• **AUTO SET GAP** ***NO LONGER USED IN SYSTEMS MANUFACTURED AFTER 2020***

The AUTO SET GAP function is used to set label sensor values. (Note that when using a Clear label detector the sensor values are not relevant) The label speed (IPM) can be set to fine tune this option. It is recommended to leave the IPM set to 300 or set it at the current application speed.

• **PRODUCT SENSOR**

This is an external device that when "activated" starts the application cycle.

PROGRAMMABLE BLOCKS:

- Product Delay – Delays the application of the label (x) seconds after the sensor has been activated.
- Sensor Trigger – Programs system to be activated at the leading or trailing edge of the trigger signal.
- On Debounce - Programs how long (seconds) a trigger signal must be received to activate system.
- Off Debounce - Used to ignore trigger signals (in seconds) after a cycle has completed.
- Multiple Feed – Programs how many system cycles occur with a single trigger signal.
- Interval Delay – Amount of time in seconds between multiple fed labels. Note: Active with quantity 2+

• **TAMP SETUP**

This is used to adjust the different variables related to the tamp cycle.

PROGRAMMABLE BLOCKS:

- Tamp Duration – Used to adjust the time that the tamp cylinder valve is actuated.
- Flag Duration – Used to adjust the time the flag jaws are held open after label application.
- Head Up Limit Switch – Type: **normally open**-standard, normally closed, none
- Head Up Debounce – Debounce is used to allow time for the tamp cylinder to settle on return.
- Vacuum Release – Used to release label when tamping on light products.
- Vacuum Delay On – Used to reduce label flutter when feeding large labels onto the vacuum platen.
- Tamp Sync - Used for "Normal" or "Reverse" Tamp signal operation.

• **ROUND MODULE SETUP**

This is used to adjust the system parameters when using the Round Module attachment.

PROGRAMMABLE BLOCKS:

- Roller Stop Delay - Delays the wrap roller from stopping after the label feed.
- Label Feed Delay - Delays the start of the label feed after the carriage pivots up.
- Roller Speed - Used to program how fast the Round Module rotates.
- Roller Acceleration - Used to control how fast the motor reaches the programmed speed.
- Jog Round Motor - Used to manually jog the motor on the Round Module.

• **LABEL SPEED**

PROGRAMMABLE BLOCKS:

- Label Speed – Used to control the speed that the label is fed through the system
- Label Acceleration - Used to control how fast the motor reaches the programmed feed speed.

• LABEL SENSOR

Provides the ability to select different label sensor types and also set the parameters within these sensor types.

PROGRAMMABLE BLOCKS:

I-Mark/Gap/CLR – Used to select type of label sensor. "Clear" used for standard applications.

Manual Set Gap – Automatically sets the emitter voltage when sensor is held on gap between labels.

- Not used in systems manufactured after 2020.

Gap Threshold – Voltage differential needed to trigger control. (sensitivity)

Label Stop Position – Electronically adjusts label stop position in reference to the peeler plate point.

Missing Label Detect - Turns on the missing label alarms and enables the auto advance feature.

Label Length - Used to program the length of the label being used.

Label Gap Length - Used to program the length of the gap between each label.

• COUNTER

Used to reset the internal Total Counter or Batch Counter of the control.

• CYCLE TYPE

Cycle Type determines the application type and sequence in relation to the label feed.

PROGRAMMABLE BLOCKS:

- *No Tamp*
- *Tamp Before Feed*
- *Tamp After Feed*
- *Blow Before Feed*
- *Blow After Feed*
- *Clam Shell Before*
- *Clam Shell After*
- *Round Module*
- *Auto Round Module*

• PRINTER SETUP

Used to control the system operation when an external printer is connected to the applicator.

Printer - On/Off

Reprint - On/Off

Printer Ready - Enable or Disable monitoring of Printer Ready Signal.

Printer Ready Fault Timer - Programmable timer for monitor of End of Print Signal & Fault Output.

Print a Label - Signals External Printer to print a single label.

Cycle with No Print - Cycles the applicator system without signaling the printer to print a label

Clear Label Buffer - Clears the printer buffer of the external printer (Doesn't work w/ all printer models)

• JOB STORAGE

Used to store frequently used settings pertaining to different labeling jobs.

PROGRAMMABLE BLOCKS:

Job Status – Displays if jobs are filled or empty (1-6)

Read a Job – Restores saved job (1-6)

Write a Job - Saves settings to specified job (1-6)

Delete a Job - Deletes the saved job file (1-6)

Delete All Jobs - Deletes all saved job files

• DEFAULT SETTINGS

Selecting this option will return the controller to the factory default settings.

PROGRAMMING FLOW CHART

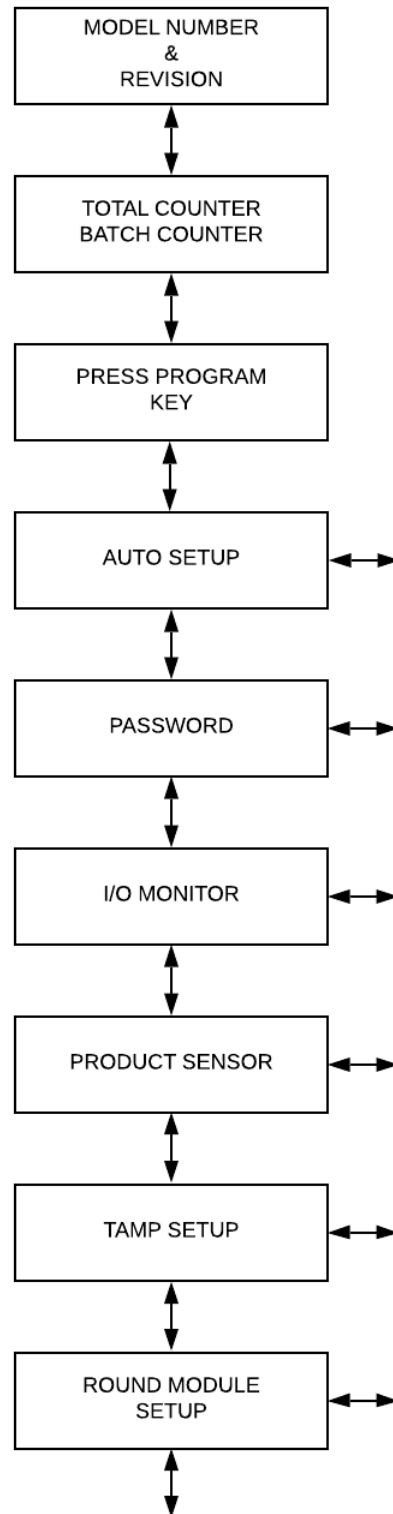

LABELMILL MODEL LM1012TTS

UP & DOWN ARROW KEYS WILL SCROLL THROUGH THE PROGRAM BLOCKS & SUB MENUS

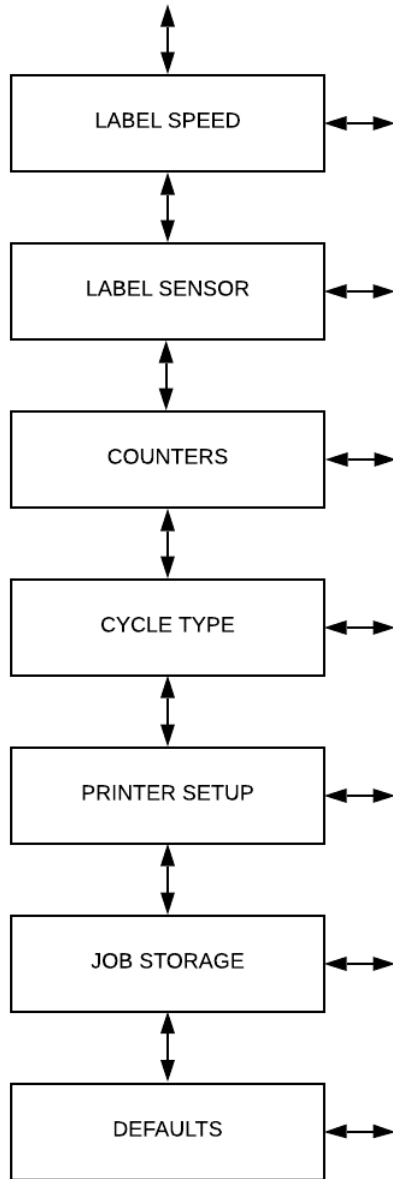

MAIN DISPLAYS

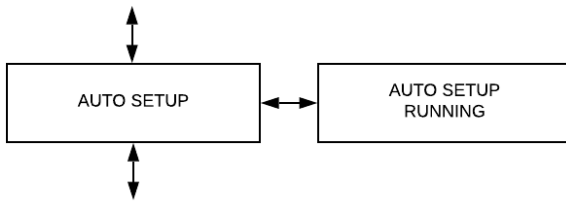

****Auto Setup is no longer used with the new style label sensor. Do not use this feature with any system built after year 2020.***

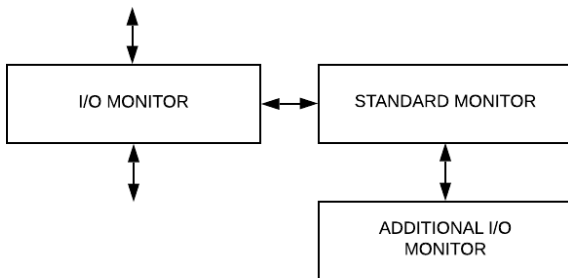
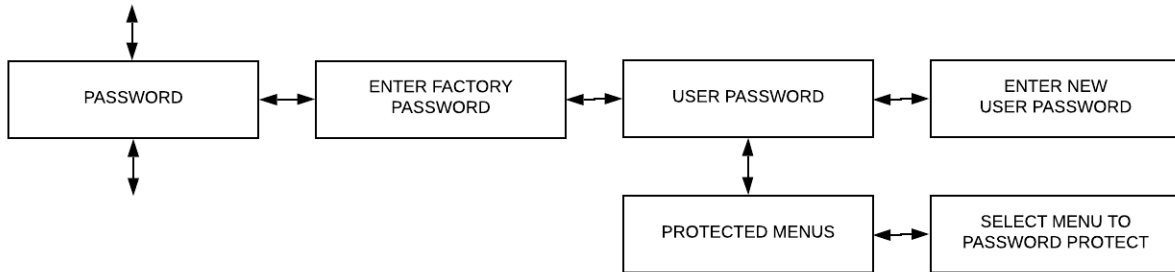

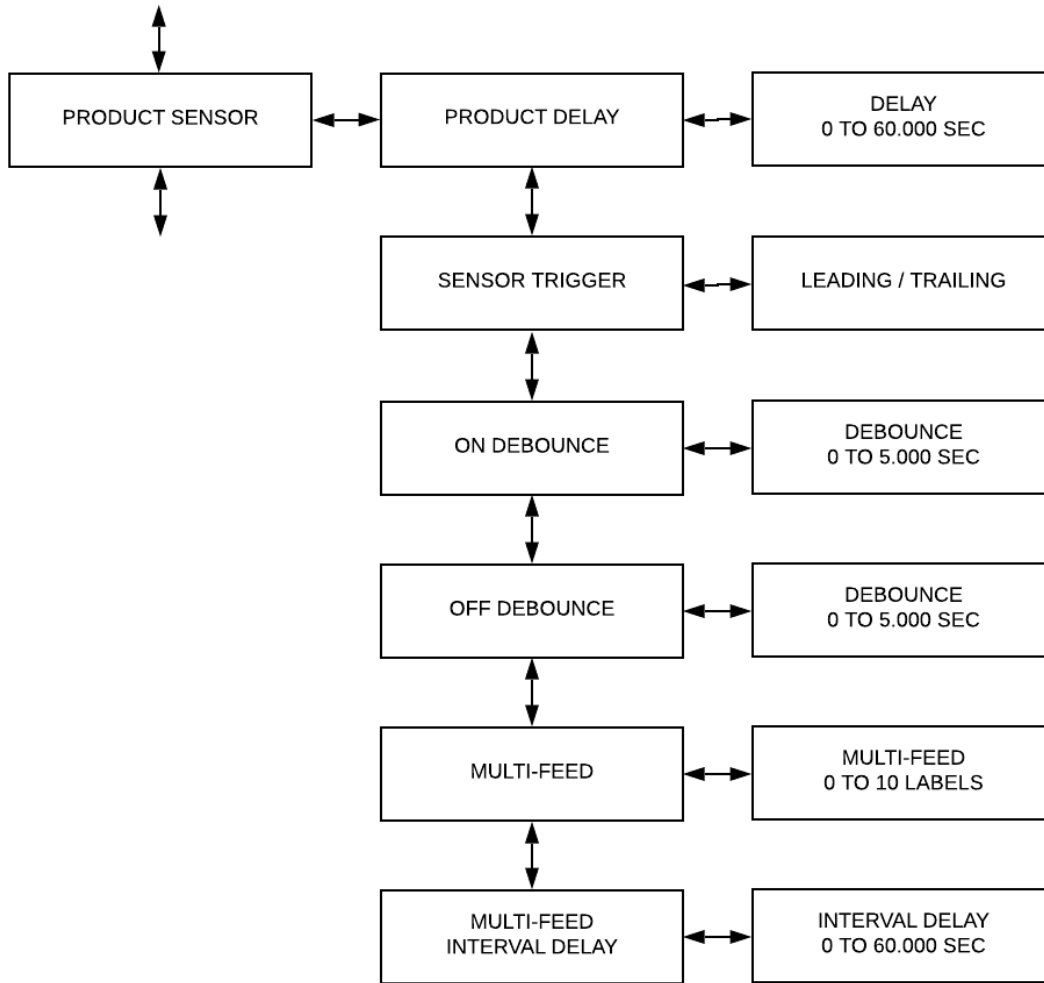

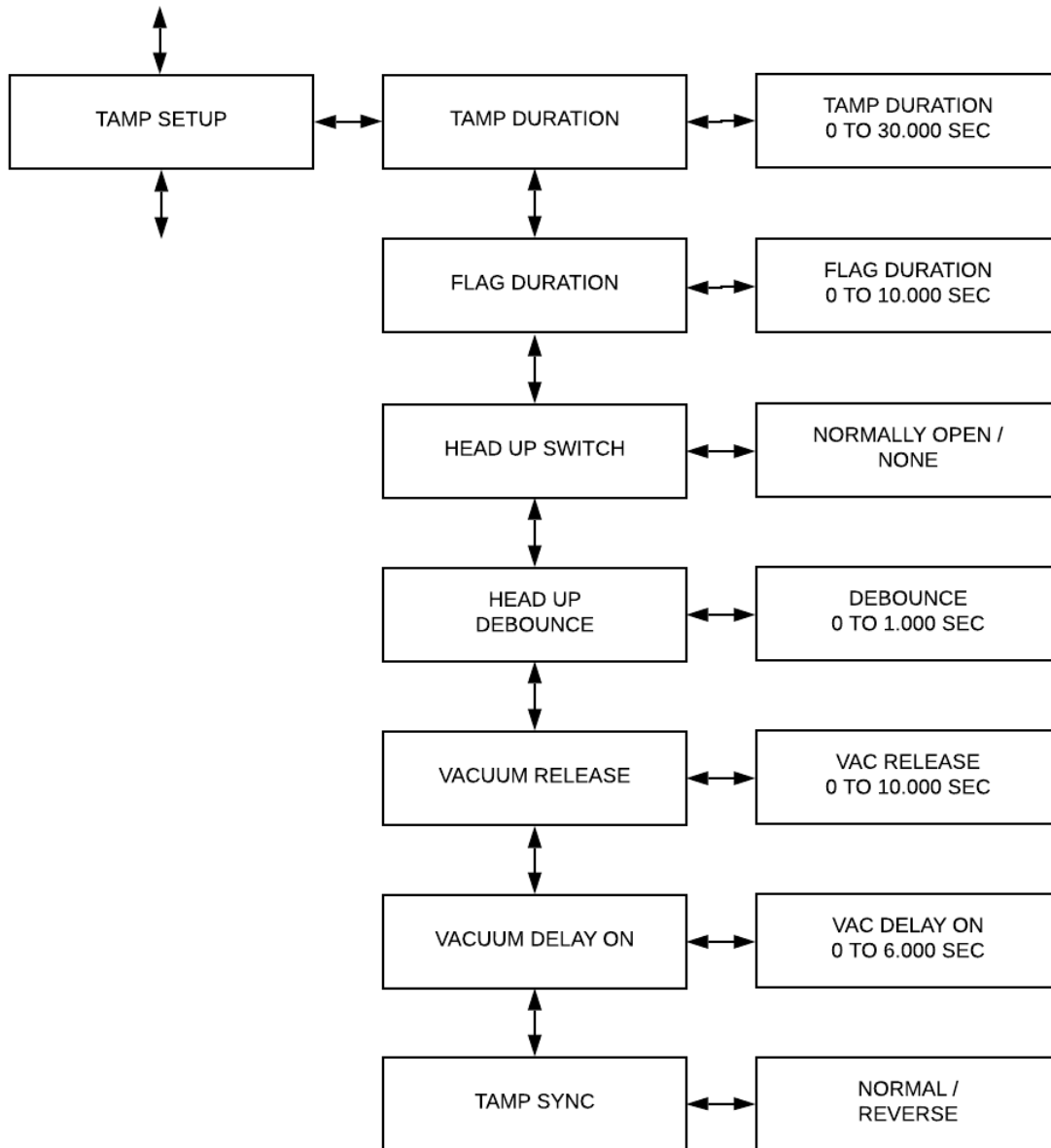

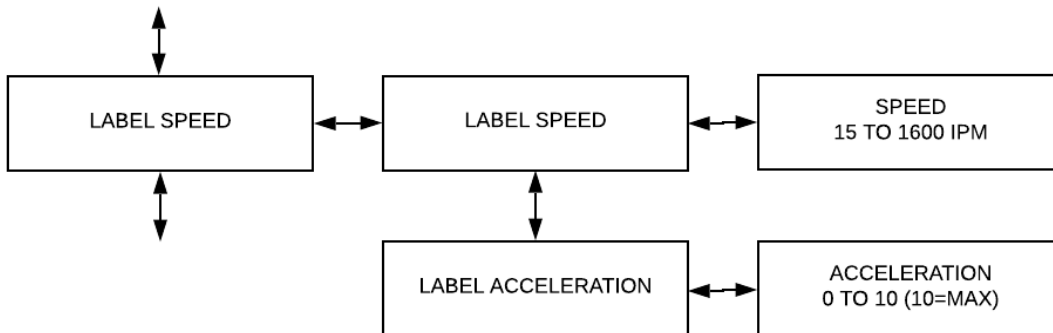
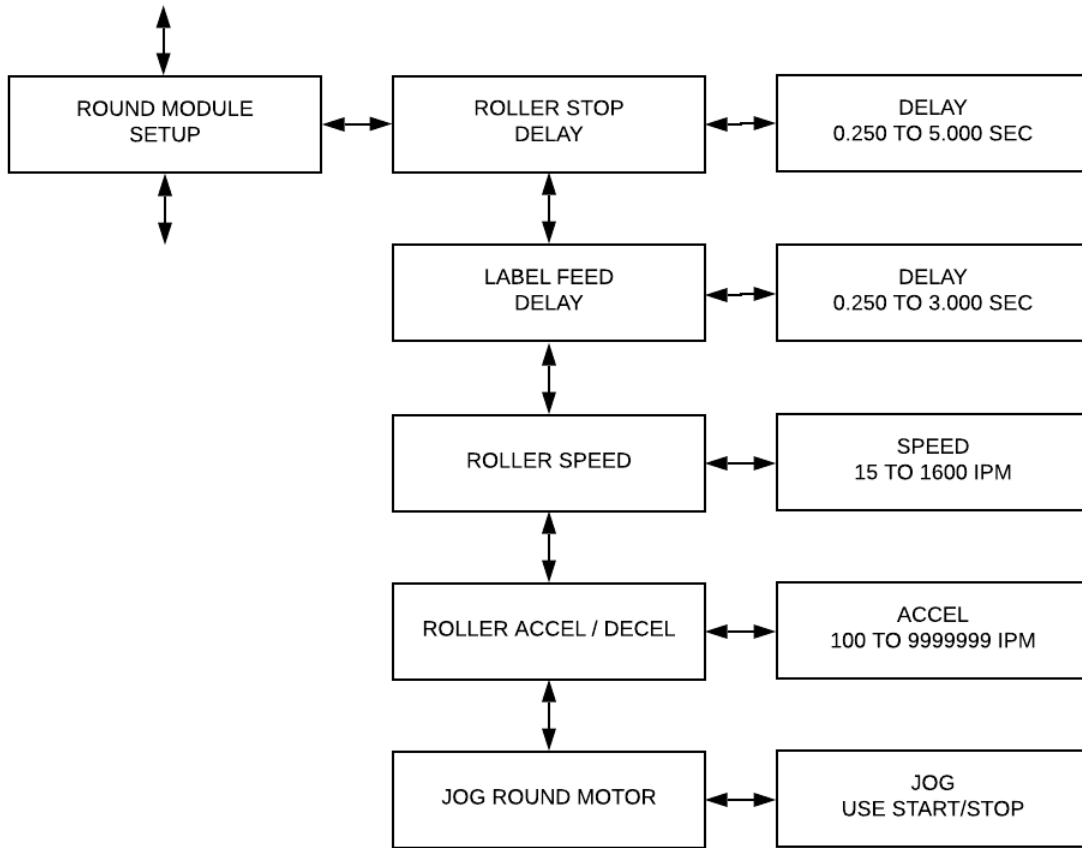

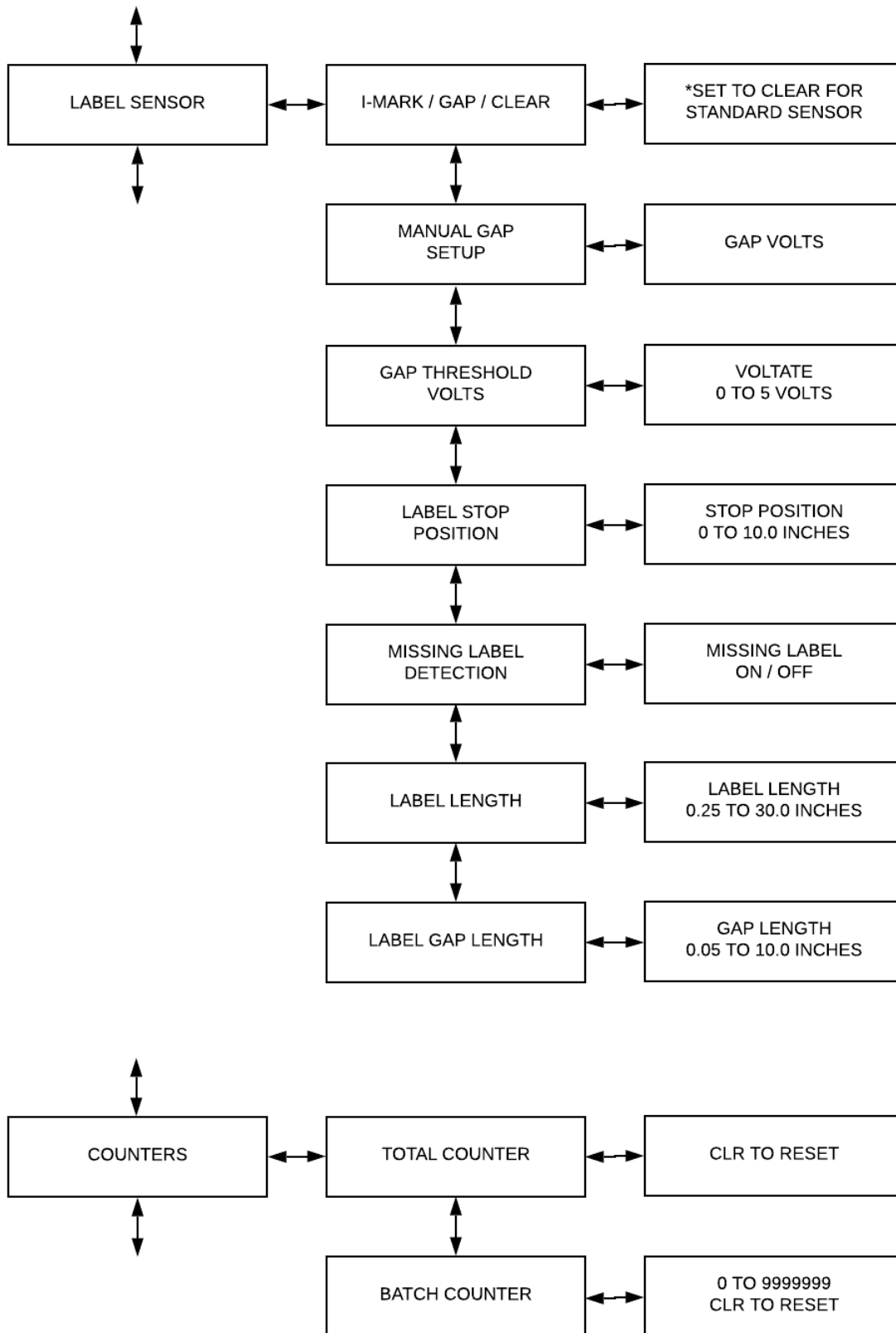

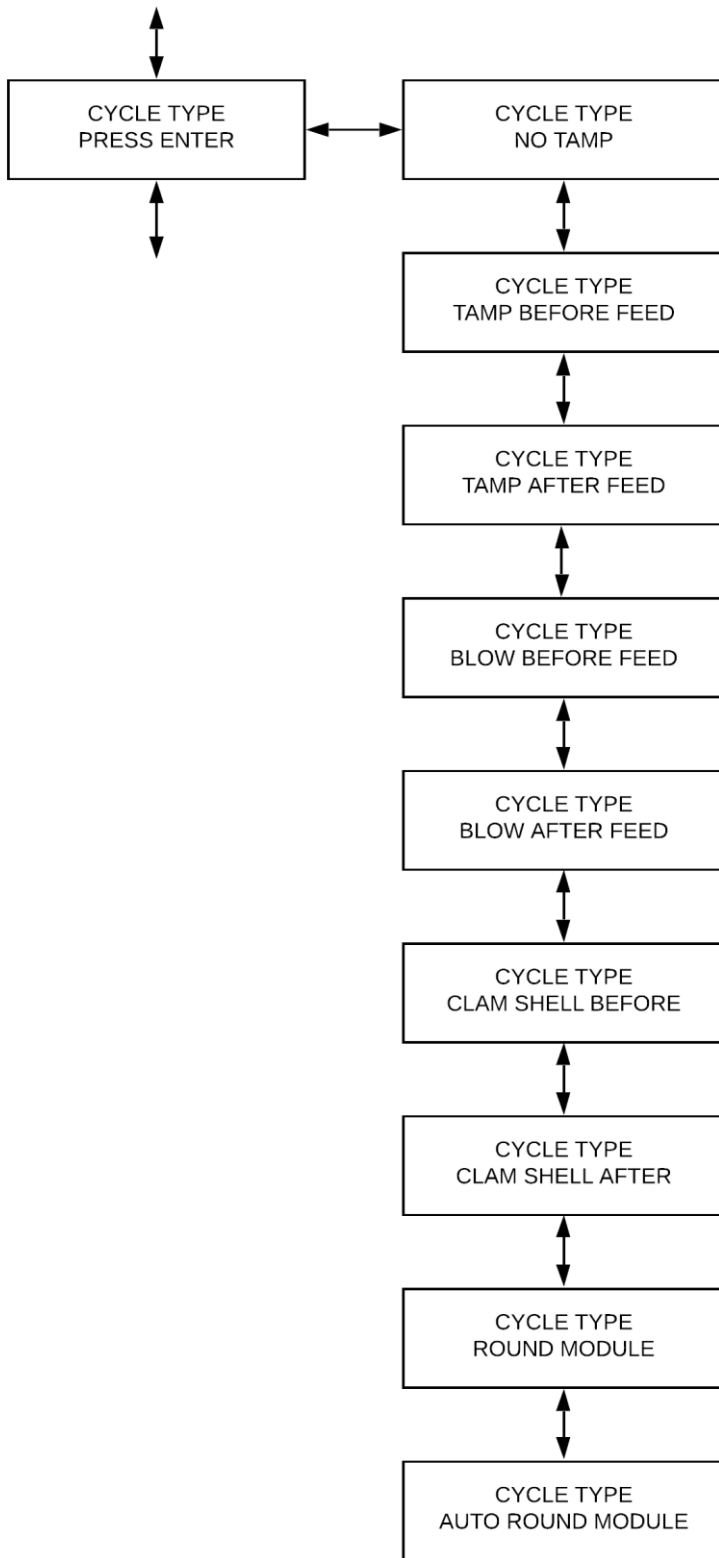

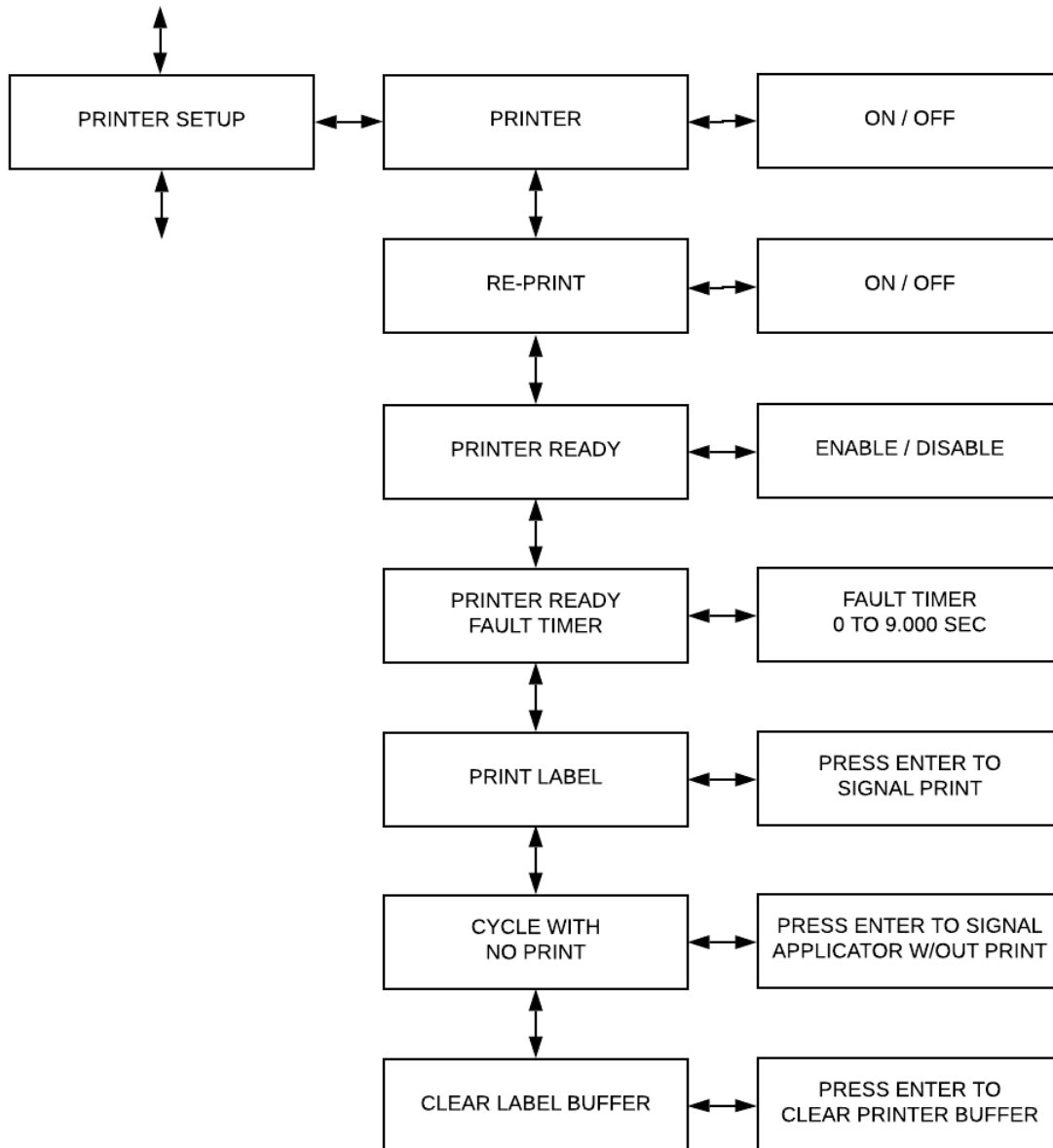

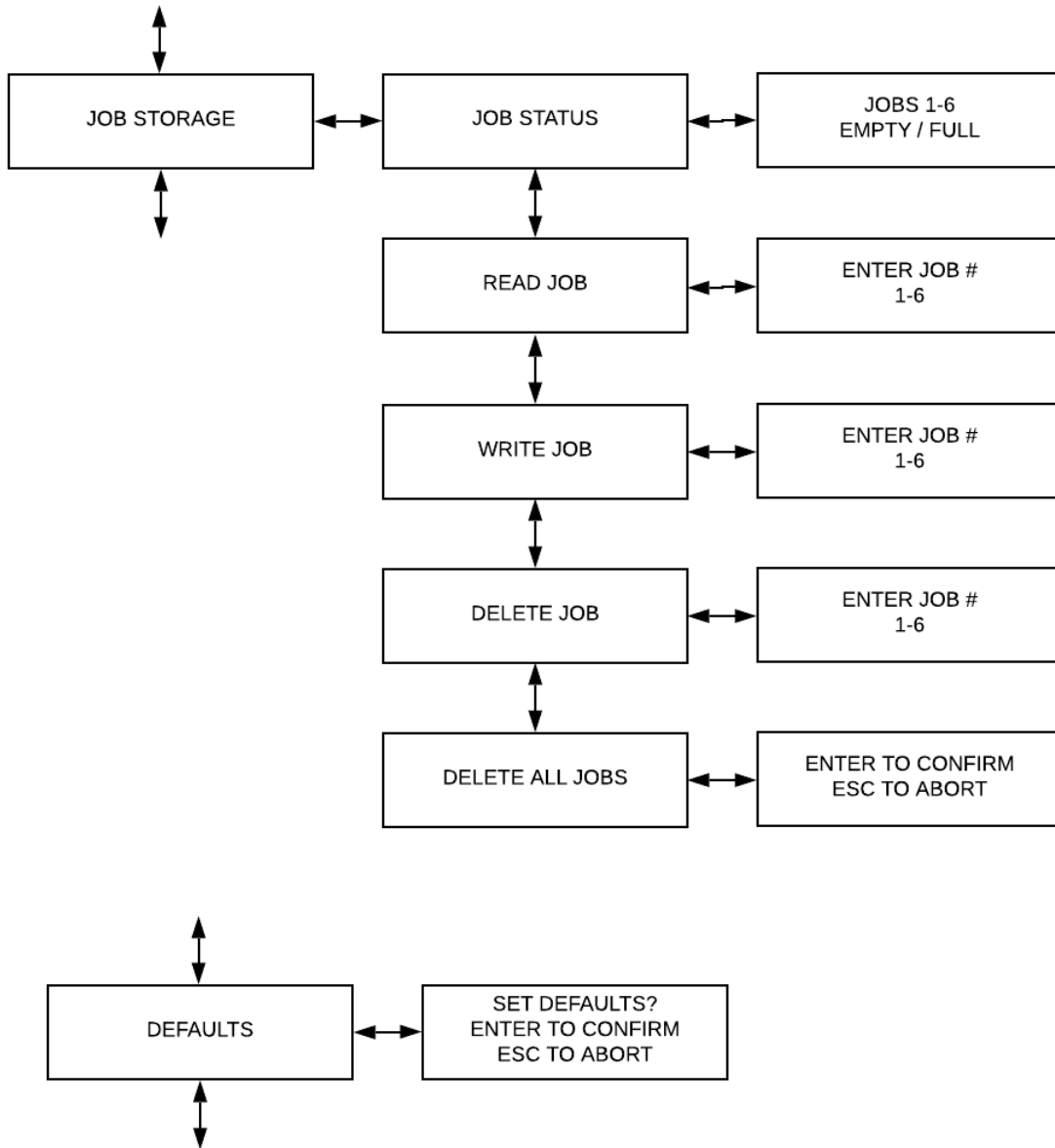

KEY DEFINITIONS

- **ASYNCHRONOUS OPERATION** – The term “ASYNCHRONOUS OPERATION” is used because the speed of the applicator motor (label speed) does not necessarily match the speed of the product conveyor. In other words their speeds are set independently of one another and have NO interrelation. An example of this is when the applicator is configured in the tamp mode.
- **SYNCHRONOUS OPERATION** – The term “SYNCHRONOUS OPERATION” is used because the speed of the applicator motor (label speed) is matched to the speed of the product conveyor.
- **PRODUCT DELAY** is used to electronically move the placement of the label on a moving product. Product delay will move the label placement in time (00.000) seconds. Because the product delay feature utilizes time, the speed of the product **MUST** remain constant. A product traveling at a higher velocity will travel further in a given time, thus effecting the placement of the label.

QUICK START GENERAL SETUP

1. Inspect applicator system and verify all cables are installed properly.
2. Web system with labels.
3. Turn power switch on.
4. Press “PROG” key to enter setup menu.
5. Use up or down arrows to reach "CYCLE TYPE" menu.
6. Press “ENTER” key on "CYCLE TYPE"
7. Select "No Tamp" option and press "ENTER" key to save.
8. Use up or down arrows to reach "LABEL SENSOR" menu, and press "ENTER" key.
9. Use up or down arrows to reach "I-MARK / GAP / CLEAR" menu, and press "ENTER" key.
10. Use up or down arrows to reach "CLEAR" option, and press "ENTER" key.
11. Press "PROG" key to exit the programming menu and return to main screen.
12. Cycle system twice by pressing the “START” key.
13. Observe label speed and change if required.
14. Manually move the label sensor if needed so that the label stops flush with the peeler plate tip.

System is now ready for set up of advanced features & options.

SETUP OF KEY FEATURES

- **LABEL STOP POSITION**

The LABEL STOP POSITION setting (in the Label Sensor menu) is used to electronically move the stop position of the label on the applicator ONLY.

The setup below describes how to use the LABEL STOP POSITION. The STOP POSITION is used electronically offset the stop of the label feed after the gap has been detected by the label sensor.

1. Set basic applicator up first, refer to quick start general setup.
2. Operate applicator at desired label speed.
3. Manually move the label sensor to adjust the label stop position. The proper stop position will be with the leading edge of the label stopping flush with the tip of the peeler plate.
4. Operate the applicator again at the same speed.
5. Does the label stop at the tip of the peeler plate? Yes = task complete NO = continue
6. Enter a small distance in the LABEL STOP POSITION.
7. Operate system at the same speed again and check label offset.
8. Make the necessary adjustments to the LABEL STOP POSITION.
9. Test again; repeat if necessary until label is in proper registration to the peeler plate tip.

Note: The LABEL STOP POSITION distance CANNOT be greater than half the length of the label. If the STOP POSITION distance is too large, inconsistent and double label feeding may occur.

HOW TO SET UP AN ASYNCHRONOUS APPLICATION

TAMP SETUP

Determine the following and select it in the software

1. Type of application mode - MENU "CYCLE TYPE"
2. Tamp before or after feed (before feed is standard)
3. Enter a value in the tamp duration (start with 00.200) - MENU "TAMP SETUP"
4. Set head up limit switch, normally open is standard - MENU "TAMP SETUP"
5. Set Label Speed to appropriate value - MENU "LABEL SPEED"
6. Adjust position of Label Sensor so that label stops at edge of peeler plate.

FLAG SETUP

Determine the following and select it in the software

1. Type of application mode - MENU "CYCLE TYPE"
2. Tamp before or after feed (before feed is standard)
3. Enter a value in the tamp duration (start with 00.200) - MENU "TAMP SETUP"
4. Enter a value in the flag duration (start with 00.200) - MENU "TAMP SETUP"
5. Set head up limit switch, normally open is standard - MENU "TAMP SETUP"
6. Set Label Speed to appropriate value - MENU "LABEL SPEED"
7. Adjust position of Label Sensor so that label stops at edge of peeler plate.

BLOW SETUP

Determine the following and select it in the software

1. Type of application mode - MENU "CYCLE TYPE"
2. Blow before or after feed (before feed is standard)
3. Enter a value in the tamp duration (start with 00.100) - MENU "TAMP SETUP"
4. Set head up limit switch, NONE is standard - MENU "TAMP SETUP"
5. Set Label Speed to appropriate value - MENU "LABEL SPEED"
6. Adjust position of Label Sensor so that label stops at edge of peeler plate.

CLAMSHELL FLAG SETUP

Determine the following and select it in the software

1. Type of application mode - MENU "CYCLE TYPE"
2. Clamshell before or after feed (before feed is standard)
3. Enter a value in the tamp duration (start with 00.200) - MENU "TAMP SETUP"
4. Enter a value in the flag duration (start with 00.200) - MENU "TAMP SETUP"
5. Set head up limit switch, normally open is standard - MENU "TAMP SETUP"
6. Set Label Speed to appropriate value - MENU "LABEL SPEED"
7. Adjust position of Label Sensor so that label stops at edge of peeler plate.

DESCRIPTION OF I/O

LEGEND

24V OPT: 24V OPTO INPUT WITH INTERNAL 24V COMMON
OH: HIGH CURRENT OUTPUT Rated @ 500ma

All user inputs and outputs are **"SINKING"** type. Example in order for a status light to illuminate for "Run Status Ok" the light should be wired between pins #2 & #8 on the **"Light Bar/Aux."** Connector.

System I/O status can be viewed through the "I/O Monitor" menu on the system control (shown below).

X=On
0=Off



LOGIC BOARD

REMOTE TRIGGER CONNECTOR (PRODUCT SWITCH)	P7 PIN #	I/O	I/O Monitor ADDRESS
+24vdc	1		
+24vdc	2		
Trigger Input #1	3	Input	X0.0
Two Hand Start AUX1	4	Input	X0.1
24v Common	5		
24v Common	6		
Shield			

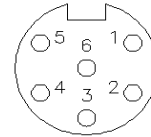

HEAD-UP / AUX IN	P8 PIN #	I/O	I/O Monitor ADDRESS
+24vdc	1		
+24vdc	2		
Head – Up/ Index Dwell	3	Input	X0.2
RM Part Present / Smart Tamp	4	Input	X0.3
24v Common	5		
24v Common	6		
Shield			

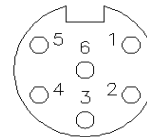

SMART TAMP	P2 PIN #	I/O	ADDRESS
+24vdc	1		
+24vdc	2		
2 nd Trigger / Pre-Print AUX1	3		X0.1
Smart Tamp	4		X0.3
24v Common	5		
24v Common	6		
SHIELD			

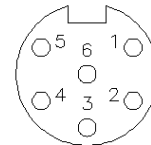

SOLENOIDS	P6 PIN #	I/O	I/O Monitor ADDRESS
Aux Output #2 / Tamp Slide	1	Output	Y1.7
+24 Volt	2		
No connection	3		
Air Assist Sol 24vdc	4	Output	Y0.0
Vacuum Sol 24vdc	5	Output	Y0.2
Tamp Sol 24vdc	6	Output	Y0.3
Flag Sol 24vdc	7	Output	Y0.1
Shield			

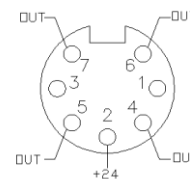

LABEL SENSOR	P4 PIN #	I/O	I/O Monitor ADDRESS
Clear / Digital Label Detector	1	Input	
24v Common	2		
(+5vdc) LED / Anode	3		Red
Take up output	4		
Logic Gnd (Led Cathode)	5		Black
Sensor Emitter (+)	6		White
Sensor Collector (-)	7		Green
+24vdc	8		
Shield			

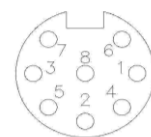

Two DB-15 Aux Connectors are available

LIGHT BAR/AUXILIARY CONNECTOR DB-15 FEMALE	P10 PIN #	INPUT/ OUTPUT	ADDRESS	
+24VDC	1			
+24VDC	2			
24 COM	3			
24 COM	4			
LOW LABEL IN	5	I	X0.5	
ERROR LIGHT (Red light)	6	O	Y0.6	On=GREEN Off=RED
LOW LABEL (Yellow light)	7	O	Y0.7	
RUN STATUS OK (Green Light)	8	O		Green = /Red
TAMP SYNC OUT	9	O	Y1.1	
INHIBIT IN	10	I	X0.6	
Aux Input #2	11	I	X0.7	
Aux Input #3	12	I	X1.1	
Aux Input #4	13	I	X1.2	
Applicator in cycle output (Applicator Busy)	14	O	Y1.2	
Batch Done Aux Output #1	15	O	Y1.6	

Round Module / Serial Plus Port DB9 Female	P11 PIN #	INPUT/ OUTPUT	ADDRESS	
SHIELD	1			
+485 RS232 XMIT (port D) to motor	2			
-485 RS232 RECV (port D) to motor	3			
24C	4			
24C	5			
Tamp Slide / Aux Output #2 High current	6	O	Y1.7	
Aux Input #2	7	I	X0.7	
+24	8			
+24	9			

PRINTER INTERFACE 14 pin Centronix	P9 PIN #	I/O	I/O Monitor ADDRESS
Paper End	1	Input	X1.3
Printer Ground	2		
Ribbon End	3	Input	X1.4
Printer Error	4	Input	X1.5
Print Start	5	Output	Y0.4
Print End	6	Input	X1.6
Reprint	7	Output	Y0.5
	8		
ONLINE (Sato Only) (Zebra Data Ready)	9	INPUT	X1.7
Ribbon Near End	10	Input	X1.0
	11		
	12		
+5vdc From Printer	13		
	14		
Shield			

DRIVE MOTOR CONNECTOR 7 pin	P12 PIN #
24vdc High Power	A1
ENC A	1
ENC B	2
GND	3
GND	4
+5vdc	5
24vdc High Power	A2

SECTION 4

OPTIONAL APPLICATION MODULES

Tamp Applicator Module Installation	39
Tamp Module Setup	40
Flag Applicator Module Installation	41
Flag Module Setup	42
Round Product Applicator Module Installation	43
Round Product Applicator Module Setup	44
Auto Round System Module Installation	45
Remote Start Module	46
Valve Pack	47
Module Air Connections	48
Peeler Plate Adjustment	49
External Printer Interface	50

Tamp Applicator Module Installation

The Tamp Applicator Module shown below can be installed in a few minutes to the existing LM1012TTS system dispenser unit.



ACTIONS TO INSTALL TAMP MODULE

1. Set the main power switch to the OFF position.
2. Disconnect the AC power cable from the rear of the console.
3. Remove any installed module or photoeye mounted to the guide rails.
4. Carefully slide the tamp module onto the rails until the unit is in the proper position.
5. Install and tighten the mounting knobs through the slotted holes on either side of the mounting rails.
6. Install the cable from the valve assembly into the connector on the accessory panel of the control box tagged "SOLENOIDS", if it is not already connected.
7. Install the cable from the tamp module head up switch into the connector on the accessory panel of the control box tagged "HEAD UP/AUX".
8. Install the four (4) air lines fitted with quick disconnect style fittings on the manifold plate above the solenoids. They are marked 1, 2, 3, and 4.
9. Install the cable into the connector on the accessory panel of the control box tagged "REMOTE TRIGGER". (Foot Switch, Palm Button, or Trigger Switch)
10. Connect the power cable and turn the unit on.
11. Program the control Cycle Type for Tamp (Before or After Feed).
12. Program the Tamp Duration in the Tamp Setup Menu.
13. Program the Head Up Switch to N.O. in the Tamp Setup Menu.
14. Adjust the label sensor, and label speed until both are functioning properly.

Tamp Module Setup

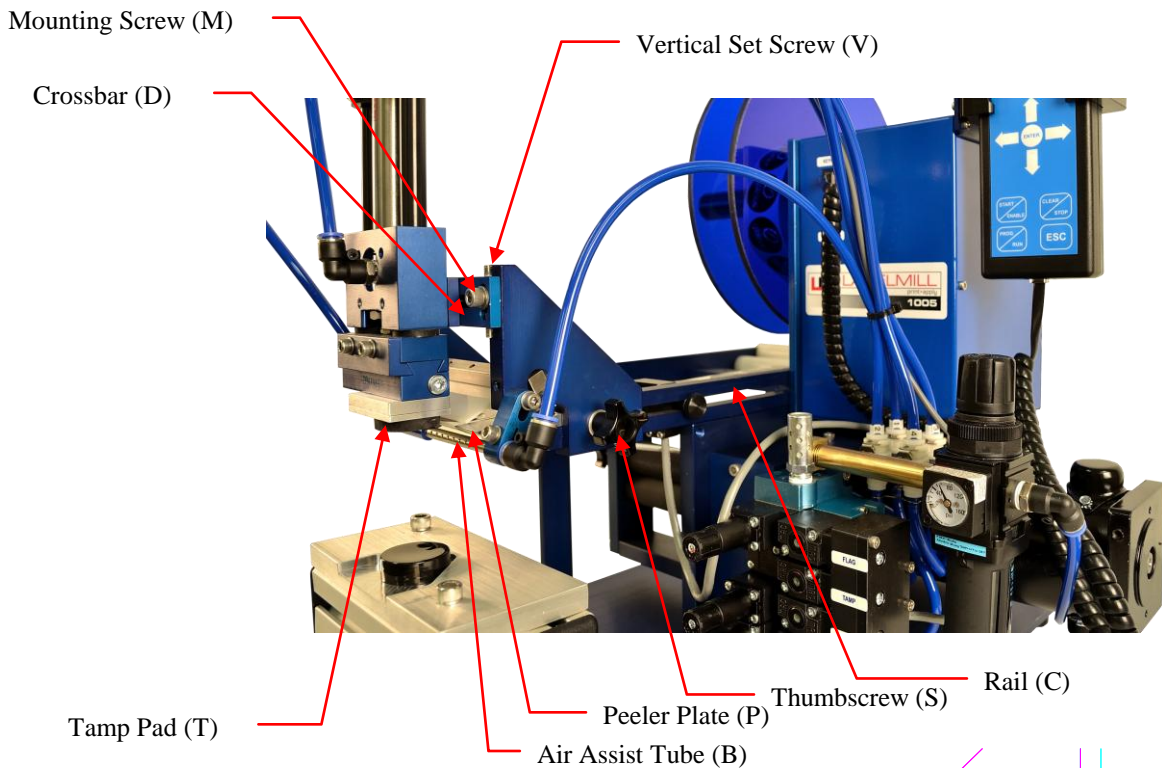

Tamp pad adjustment

1. To adjust the tamp pad (T) in relationship to the peeler plate (P) in the horizontal plain, loosen the thumbscrews (S) and move the tamp module forward or backward in the slots. There should be approximately .020" (A) gap between the tamp pad (T) and the peeler plate (P). The tamp pad (T) can also be adjusted left to right in relation to the peeler plate (P) via the slot in the top of the crossbar (D). **NOTE:** The center of the tamp pad should be at the center of the label.
2. To adjust the tamp pad (T) in relationship to the peeler plate (P) in the vertical position, loosen the mounting screw (M) and adjust the vertical screws (V) in or out to achieve the .020" (B). **NOTE:** The tamp pad (T) must maintain parallelism with the peeler plate (P).

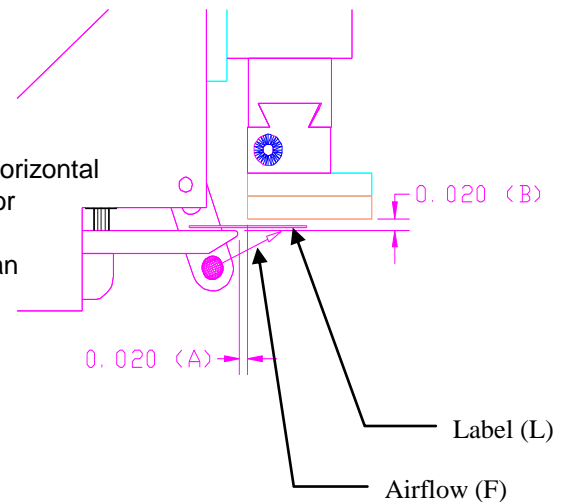

Air assist tube adjustment

1. Adjust the air-assist tube (B) so that the small holes aim towards the center of the label as shown by the arrowhead (F) shown above. The air assist tube (B) aids the label (L) to adhere to the bottom of the tamp pad (T). Once the label (L) is "blown" onto the tamp pad (T), it is held there by vacuum.
2. Once the above adjustments are made, adjust the vacuum regulator, the air assist regulator, and the flow controls as needed.

Note: Too much pressure on the air assist will cause the label to flutter and/or blow off of the vacuum platen.

Flag Applicator Module Installation

The Flag Applicator Module shown below can be installed in a few minutes to the existing LM1012TTS system dispenser unit.



ACTIONS TO INSTALL FLAG MODULE

1. Set the main power switch to the OFF position.
 2. Disconnect the AC power cable from the rear of the console.
 3. Remove any installed module or dispenser photo-eye mounted to the guide rails.
 4. Carefully slide the flag module on to the rails until the unit is in the proper position (following Tamp Module Setup).
 5. Install and tighten the mounting knobs through the slotted holes on either side of the mounting rails.
 6. Install the cable from the valve assembly into the connector on the accessory panel of the control box tagged "SOLENOIDS", if it is not already connected.
 7. Install the cable from the tamp module head up switch into the connector on the accessory panel of the control box tagged "HEAD UP/AUX".
 8. Install the six (6) airlines fitted with quick disconnect style fittings on the manifold plate above the solenoids. They are marked 1, 2, 3, 4, 5, and 6.
 9. Install the cable into the connector on the accessory panel of the control box tagged "REMOTE TRIGGER" (Foot Switch, Palm Button, or Trigger Switch).
 10. Connect the power cable and turn the unit on.
 11. Program the control Cycle Type for Tamp (Before or After Feed).
 12. Program the Tamp Duration in the Tamp Setup Menu.
 13. Program the Flag Duration in the Tamp Setup Menu.
 14. Program the Head Up Switch to N.O. in the Tamp Setup Menu.
 15. Adjust the label sensor, and label speed until both are functioning properly.
 16. Adjust the flag jaw pressure on the Flag Valve of the Valve Pack. To adjust the jaws, start with the pressure low and increase pressure as needed to achieve proper wrap of the label on the product.
- NOTE: Low pressure will not close the jaws, and high pressure will not label consistently or may cause product breakage.

Flag Module Setup

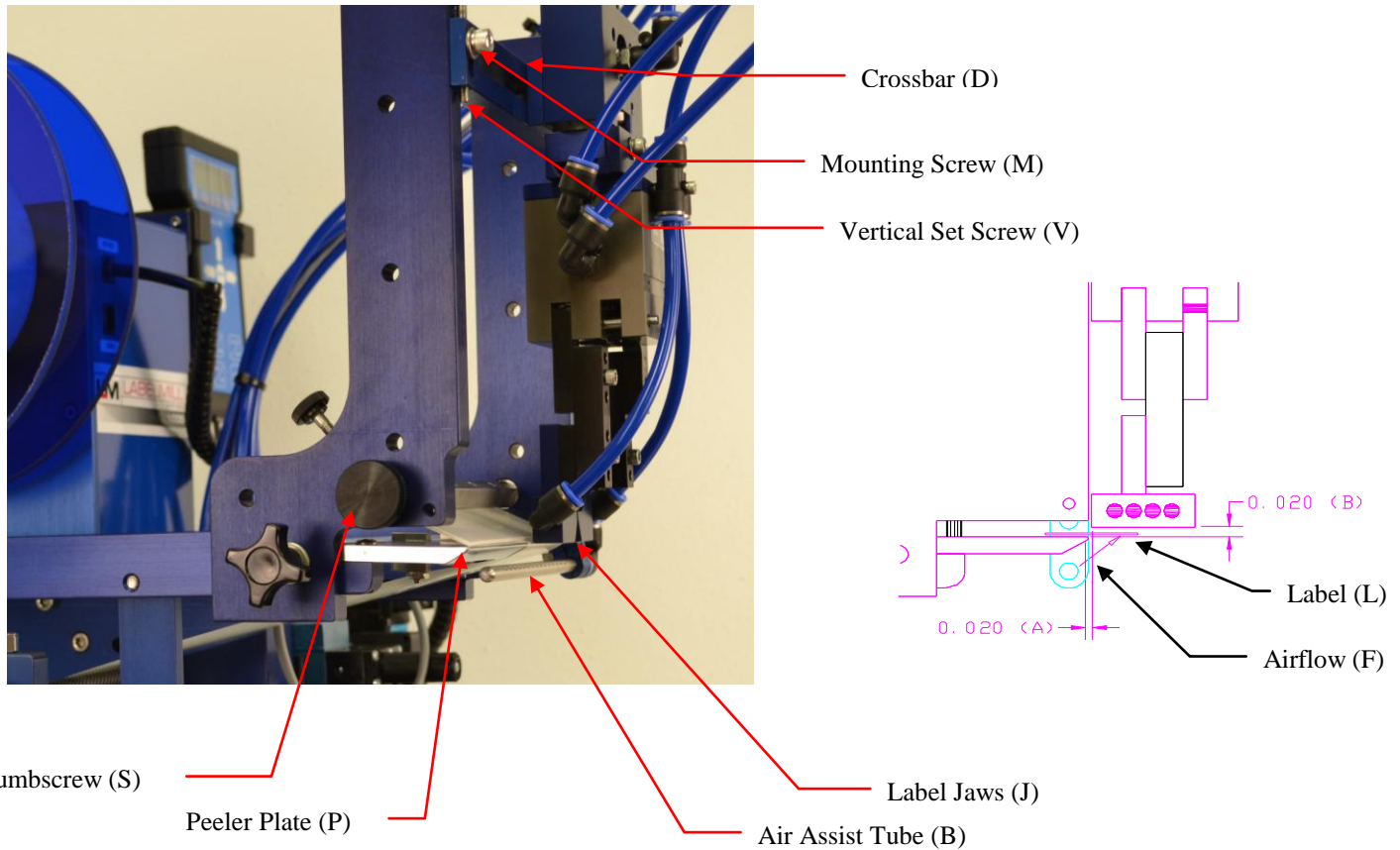

Label jaw adjustment

1. To adjust the label jaws (J) in relationship to the peeler plate (P) in the horizontal plain, loosen the thumbscrews (S) and move the flag module forward or backward in the slots. There should be approximately .020" (A) gap between the label jaws (J) and the peeler plate (P). The jaws (J) can also be adjusted left to right in relation to the peeler plate (P) via the slot in the top of the crossbar (D). **NOTE:** The center of the jaws should be at the center of the label.
2. To adjust the label jaws (J) in relationship to the peeler plate (P) in the vertical position, loosen the mounting screw (M) and adjust the vertical screws (V) in or out to achieve the .020" (B). **NOTE:** The label jaws (J) must maintain parallelism with the peeler plate (P).

Air assist tube adjustment

1. Adjust the air assist tube (B) so that the small holes aim towards the center of the label as shown by the arrowhead (F) shown above. The air assist tube (B) aids the label (L) to adhere to the bottom of the label jaws (J). Once the label (L) is "blown" onto the label jaws (J), it is held there by vacuum.
2. Once the above adjustments are made, adjust the vacuum regulator, the air assist regulator, and the flow controls as needed.

Note: Too much pressure on the air assist will cause the label to flutter and/or blow off of the vacuum platen.

Round Product Applicator Module Installation

The Round Product Applicator Module shown below can be installed in a few minutes to the existing LM1012 system dispenser unit.



ACTIONS TO INSTALL ROUND PRODUCT MODULE

1. Set the main power switch to the OFF position.
2. Disconnect the AC power cable from the rear of the console.
3. Remove any installed module or photoeye mounted to the guide rails.
4. Carefully slide the round product module on to the rails until the unit is in the proper position.
5. Install and tighten the mounting knobs through the slotted holes on either side of the mounting rails.
6. Install the cable from the round product module into the connector on the accessory panel of the control box tagged "Round Module".
7. Install the cable from the valve assembly into the connector on the accessory panel of the control box tagged "SOLENOIDS", if it is not already connected.
8. Install the cable from the round product module limit switch into the connector on the accessory panel of the control box tagged "HEAD UP/AUX".
9. Install the two (2) airlines fitted with quick disconnect style fittings on the manifold plate above the solenoids. They are marked 3 and 4.
10. Install the cable into the connector on the accessory panel of the control box tagged "REMOTE TRIGGER" (Foot Switch, Palm Button, or Trigger Switch).
11. Adjust the roller cradle up or down for the product. There should be enough room to get the product in and out, but not more than 1" of gap between the product and yellow roller.
12. Adjust the rollers on the cradle so the centerline of the product and the yellow roller are lined up.
13. Connect the power cable and turn it on.
14. Program the control Cycle Type for Round Module
15. Adjust the label sensor, and label speed until both are functioning properly
16. Adjust the Round Module Setup settings as needed.

Round Product Applicator Module Setup

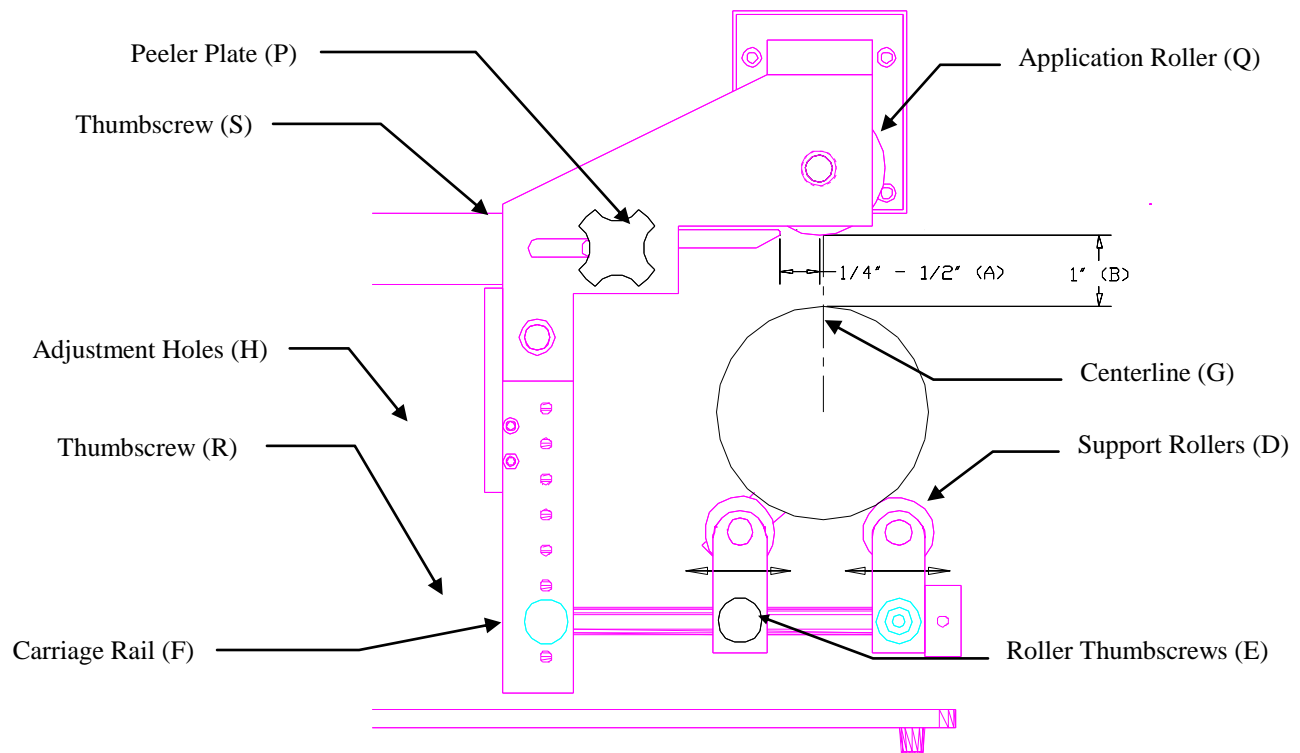

Round Module alignment

1. To adjust the round product applicator in relationship to the peeler plate (P) in the horizontal plain, loosen the thumbscrews (S) and move the round product module forward or backward in the slots. There should be approximately $\frac{1}{4}$ " - $\frac{1}{2}$ " (A) gap between the application roller (Q) and the peeler plate (P).

Bottle Roller adjustment

1. Loosen the thumbscrews (E) and adjust the support rollers (D) until the product is supported securely. These supports (D) are moved to adjust for the size, location and height of the product in relation to the label application roller (Q).
2. Thumbscrew (R) is loosened and removed to allow the cradle assembly to be moved from hole to hole on the carriage rail (F). This is a product rough adjustment.
3. Move the cradle assembly up or down and the support rollers horizontally until the desired 1" (B) of clearance between the product and the label application roller (Q) is achieved.
4. Adjust the flow controls as described on page 4-6. Flow controls in this configuration will control the speed at which the carriage moves the product up and down.

Auto Round System Module Installation

The Auto Round System Module shown below can be installed in a few minutes to the existing LM1012 system dispenser unit.

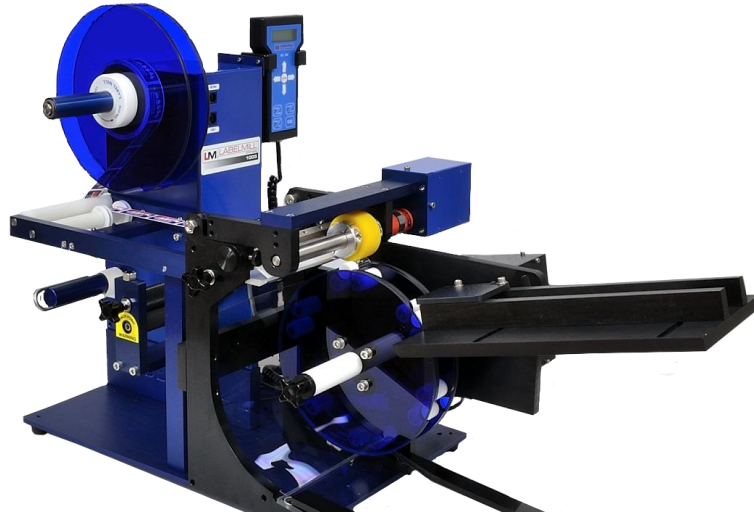

ACTIONS TO INSTALL AUTO ROUND SYSTEM

1. Set the main power switch to the OFF position.
2. Disconnect the AC power cable from the rear of the console.
3. Remove any installed module or photo-eye mounted to the guide rails.
4. Carefully slide the auto round system module onto the rails until the unit is in the proper position.
5. Install and tighten the mounting knobs through the slotted holes on either side of the mounting rails.
6. Install the cable from the auto round system module into the connector on the accessory panel.
7. Install the cable from the auto round system module limit switch into the connector on the accessory panel of the control box tagged "HEAD UP/AUX".
8. Install the cable into the connector on the accessory panel of the control box tagged "REMOTE TRIGGER" (Foot Switch, Palm Button, or Trigger Switch).
9. Adjust the product in feed chute so that the product rolls freely into the take-up wheel.
10. Adjust the take-up wheel with the product under the yellow roller. When the product is indexed to the position under the roller, the roller should be lifted enough to open the limit switch and trigger the LM1012TTS to label the product.
11. Connect the power cable and turn it on.
12. Program the control Cycle Type for "Auto Round".
13. Adjust the label sensor, and label speed until both are functioning properly.
14. The label feed speed should match to the roller motor speed. If the label motor speed is too fast, the label will bunch up. If it is too slow the product will pull the web.

Remote Start Module

The LM1012 Remote Start Module shown below can be connected to the LM1012.



PB-32
Push Button
(Remote start trigger)



FS-42
Foot Switch
(Remote start trigger)

ACTIONS TO INSTALL REMOTE START MODULE

1. Set the main power switch to the OFF position.
2. Disconnect the AC power cable from the rear of the accessory connector panel.
3. Install the cable from the remote start module into the connector on the accessory connector panel tagged "Remote Trigger".
4. Connect the power cable and turn the unit on.

Valve Pack

The LM1012TTS valve pack is used to control the air pressure & flow on the tabletop system.

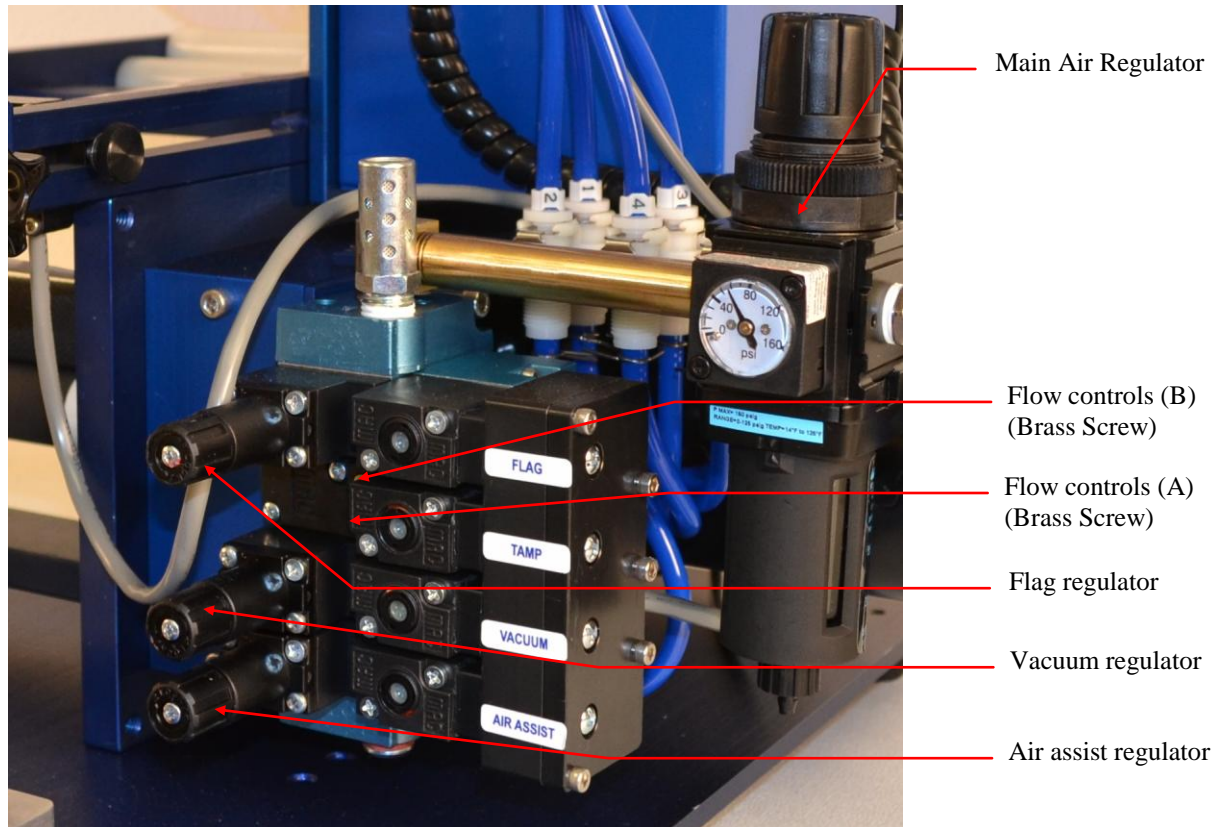

Regulator Adjustment: **Clockwise** - Increase pressure **Counterclockwise** - Decrease pressure

MAIN AIR REGULATOR

Controls maximum air pressure available to entire applicator. Should be set between 40 & 80 PSI.

FLAG REGULATOR

The flag regulator is used to adjust the pressure that the flag jaws apply to the label as it is applied. For complete jaw adjustment, refer to flag applicator module installation.

VACUUM REGULATOR (only used on the flag and tamp applicator system)

The vacuum regulator is used to control the vacuum that is used to hold the label to the flag jaws or the tamp pad.

AIR ASSIST REGULATOR

The air assist regulator is used to change the pressure that is applied to the blow tube. The blow tube is below the front edge of the peeler plate and is used to help "push" the label onto the bottom of the tamp pad or the flag jaws.

FLOW CONTROLS (tamp, round, and flag applications)

Control A: This is used to adjust the speed that the tamp cylinder moves in the upward direction.

Control B: This is used to adjust the speed that the tamp cylinder moves in the downward direction.

Module Air Connections

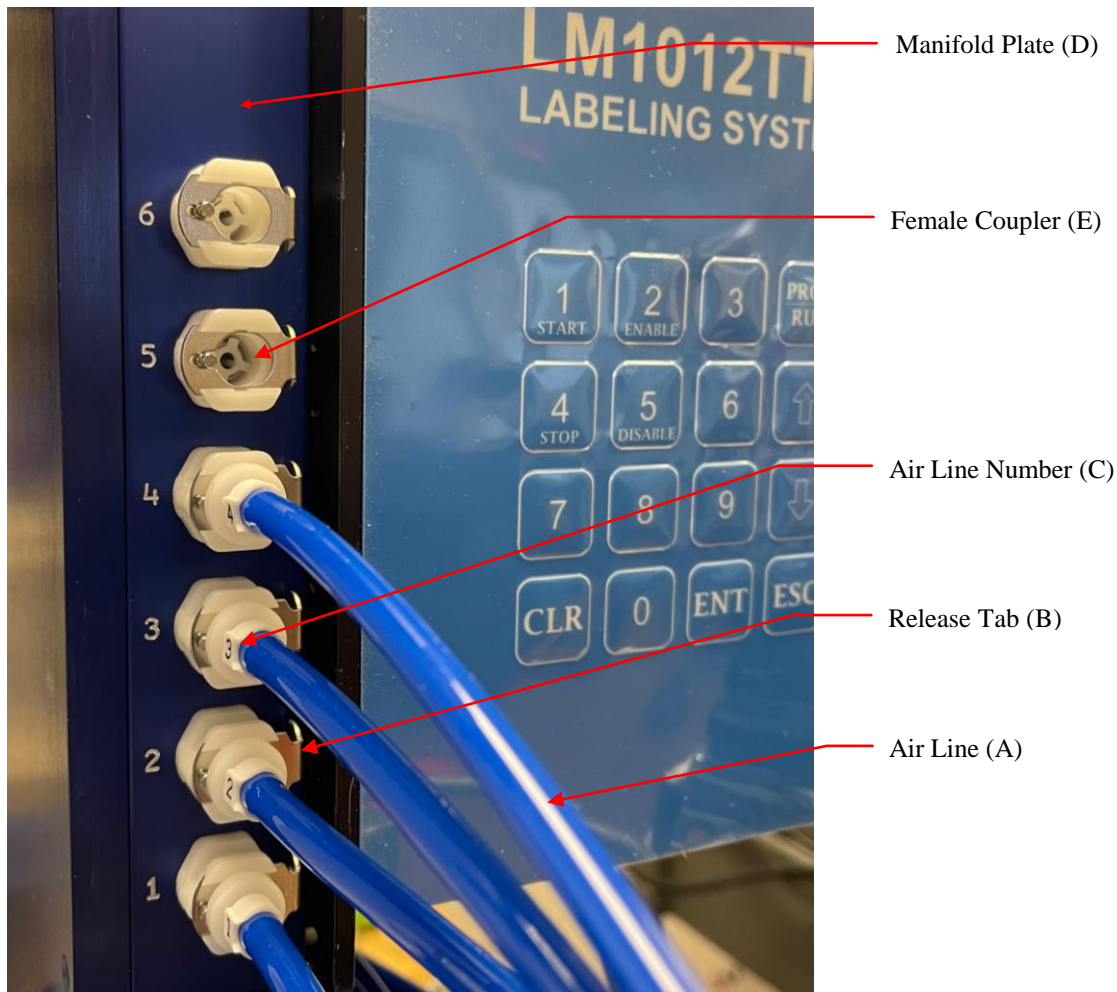

Module Air Hose Connections

1. After installing one of the 3 modules, connect the airlines (A) to the Manifold Plate (D) shown above.
2. The Air Line Numbers (C) should be matched with the numbers on the Manifold Plate (D).
3. To connect the Air Line (A) to the Manifold Plate (D), simply push the male connector of the Air Line (A) into the Female Coupler (E). It will “snap”, automatically “locking” it into place. NOTE: If the male connector of the Air Line (A) won't slide easily into the Female Coupler (E), it may be necessary to push the Release Tab (B) towards the center of the plate, locking the tab in the “open” position.
4. To release the Air Line (A) from the Manifold Plate (D), simply push the Release Tab (B) towards the center of the plate and remove the Air Line (A).

Manifold Plate (D) Number Reference

- 1) Vacuum
- 2) Air Assist
- 3) Tamp Cylinder Down / Bottle Roller Carriage Up
- 4) Tamp Cylinder Up / Bottle Roller Carriage Down
- 5) Flag Jaws Open
- 6) Flag Jaws Closed

Peeler Plate Adjustment

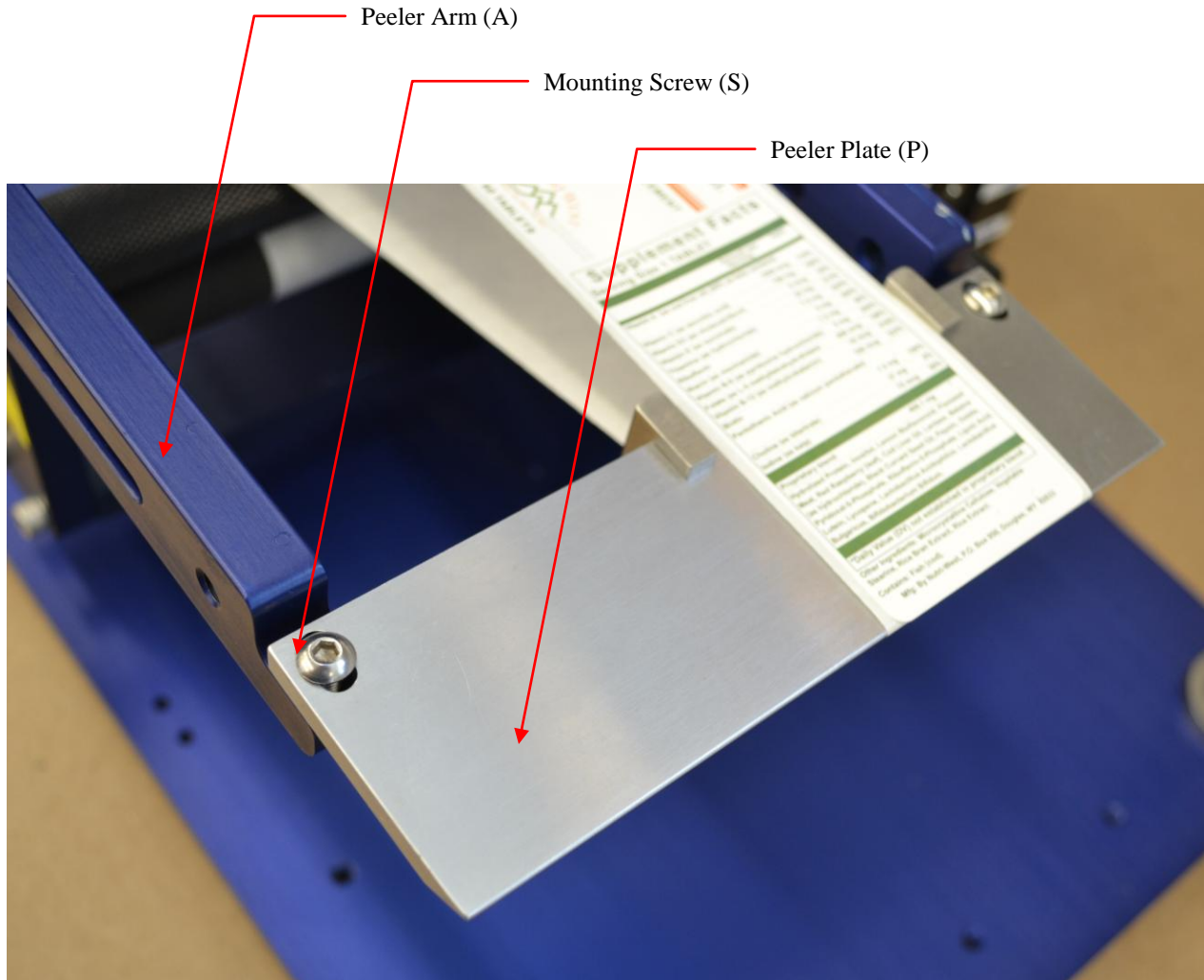

Peeler Plate Adjustment (used to adjust tracking)

1. Loosen the mounting screws (S) and slide the peeler plate (P) in the direction needed to make the label web track in the desired direction.
2. Retighten the mounting screws (S) to secure the peeler plate (P) after adjustments are made.
3. Now that the plate is adjusted, test run the machine to see if the web tracks correctly.

NOTE: If the web tracks towards the main control console, adjust the end of the peeler plate (P) away from the console or the opposite end toward the console. Adjust the peeler plate (P) in the opposite direction if the web tracks away from the control console.

Printer Interface Cable



The LabelMill Printer Interface Cable is used to interface an external printer to the LABELMILL 1012TTS to configured the system as a Loose-Loop Print & Apply System. When this is done, the printer will print a label every time the LM1012TTS is cycled. The printer must be configured through an applicator interface port. The printer operating software must also be properly set for this option to operate. To configure the printer please refer to the printer operation manual.

SET-UP

- | Step | Operation |
|------|--|
| 1 | Turn power "OFF" to the LM1012TTS. |
| 2 | Plug the Printer Interface Cable into Printer Interface port on Accessory Connector Panel. |
| 3 | Plug the other end of the Printer Interface Cable into printer Applicator Interface Port. |
| 4 | Turn power "ON" to the LM1012TTS. |
| 5 | Turn the printer option "ON" in the LM1012 control programming menu. |

SECTION 5

TROUBLESHOOTING & MAINTENANCE

Troubleshooting	52
Fault Codes	53
Spool Brake Adjustment	54
Replacing the Main Power Fuse	55

TROUBLESHOOTING GUIDE

If the system malfunctions, it is necessary to determine where the problem exists in a normal sequence of operation. The procedure of the unit is outlined in the left hand column of the table below to provide a systematic approach to troubleshooting.

Problem	Possible Cause	Corrective Action
1. Unit will not turn on.	A. Blown Main Fuse	Check main power fuse and replace if necessary as shown on page 55.
2. Take-up unit does not turn.	A. Friction plate failure in clutch. B. Mechanical failure in clutch.	Consult Factory.
3. Waste web tension too loose.	A. Clutch tension too low.	Adjust clutch as shown on page 15.
4. Waste web breaks.	A. Clutch adjusted too tight. B. Machine webbed incorrectly C. Low quality webbing. D. Friction plate failure in clutch. E. Mechanical failure in clutch.	Adjust clutch as shown on page 15. Re-web system as shown on page 10. Consult label manufacturer. Consult factory. Consult factory.
5. Label double feeds.	A. Label sensor out of adjustment. B. Label Stop Position Incorrect	Adjust setting as shown on page 11. Reduce Label Stop Position Setting.
6. Tamp cylinder not up	A. No air B. Hoses not connected correctly	Connect air and/or adjust regulator Match tubes w/ numbers on manifold.
7. Applicator module does not function	A. Incorrect Cycle Type B. No air C. Hoses not connected correctly	Set correct Cycle Type in control. Connect air and/or adjust regulator. Match tubes w/ numbers on manifold.
8. Power ON tamp/flag system unit will not cycle	Cylinder not up. Reed Switch out of adjustment Incorrect Cycle Type	Refer to #6. Adjust Switch up or down. Set correct Cycle Type in control.

FAULT CODES

DISPLAYED FAULT	DESCRIPTION	CORRECTIVE ACTION
Broken Web Fault	Too many labels missing on web Labeler not webbed properly Label sensor not adjusted properly	Check label stock. Check for proper webbing. Check Label Sensor setting.
Head Up Fault	Head up limit switch on tamp did not trigger	Check for proper adjustment of head up limit switch. Check air to system. Check programming of Tamp switch.
Head Down Fault	Head up limit switch failed to switch during the tamp cycle	Tamp duration too small. Faulty limit switch. Check air to system. Check programming of Tamp switch.
Part Present Fault	Switch on Round Module failed to change state during cycle.	Check switch function. Inspect Cable for damage. Adjust Carriage Position.
Print Timeout Fault	End of Print Signal was not received with "Printer" setting enabled	Turn off Printer setting (if external printer is not being used). Check Printer Settings. Inspect / Replace Interface Cable.

ADJUSTING THE SPOOL BRAKE

The LM1012TTS is equipped with an adjustable storage spool brake. NOTE: This is preset at the factory and usually does not require additional adjustment. If web tension problems occur, it may be necessary to adjust the storage spool brake. Some common problems are: web too loose, web breaks, and web slips in drive rollers. The storage spool brake and actions to adjust this are shown below.

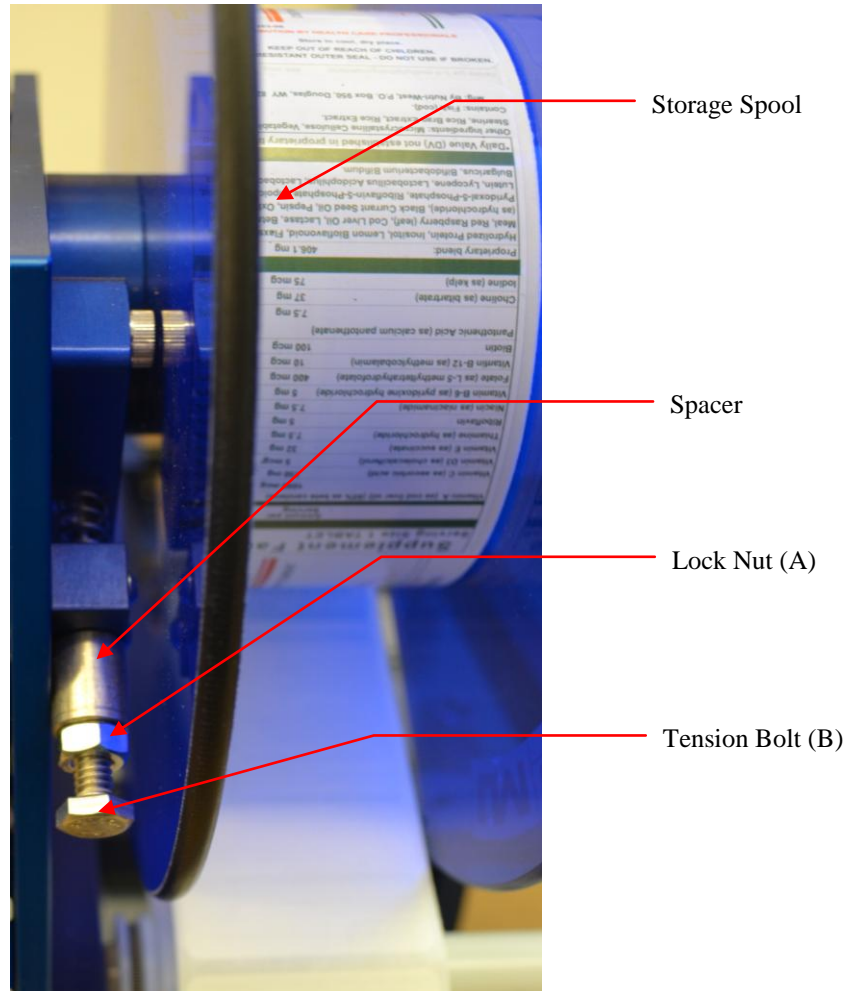

ACTIONS TO ADJUST SPOOL BRAKE

1. TURN OFF POWER TO THE MACHINE.
2. Remove the spool and remove the label stock from the machine.
3. Grab the spool with your hand and rotate it checking for any resistance.
- A. If the spool has little or no resistance, loosen the lock nut (A), and tighten the tension bolt (B) until you can feel a moderate resistance.
- B. If the spool has too much resistance, loosen the lock nut (A), and back the tension bolt out. Now check the spool to see if it spins freely on the shaft. If it spins freely, adjust as shown in "A" above. If it does not spin freely, consult the factory.
4. After adjusting the tension bolt (B), retighten the lock nut (A), re-web the machine and test the unit.

REPLACING THE MAIN POWER FUSE

The circuitry is protected from a current overload by GMA 2A a slow blow fuse. Should the applicator fail to operate, the condition of this fuse should be checked. If the fuse is open, the cause of the overload condition must be determined and corrected prior to replacing the fuse. NEVER replace the fuse with one of a greater amp rating. The specified rating has been selected to prevent damage and/or injury.

ACTIONS TO REPLACE THE MAIN FUSE

1. Set the main power switch to the OFF position.
2. Disconnect the AC power cable from the rear of the console.
3. Locate the fuse holder/power cord assembly.
4. Gently press down the fuse holder cover while pulling away from the console.
5. Replace with the spare fuse provided in the holder.



Fuse / Spare Fuse Drawer

LM1012

TABLE-TOP LABEL APPLICATOR SYSTEM

OPERATIONS MANUAL



Copyright and Trademarks

Copyright ©2022 LabelMill, Inc.
All rights reserved. All trademarks and brand names
are the property of their respective owners.

LabelMill
2416 Jackson St.
Savanna, IL 61074

Phone: (800) 273-4707; Fax (815) 273-7074
www.labelmill.com
info@labelmill.com